

- EN** Bone Surgery
- DE** Knochenchirurgie
- ES** Cirugía ósea

Page 243 to 314



BONE SURGERY



**Mead**  
12-3501-17 17.0cm  
26mm Ø, 320 g (11¼ oz)

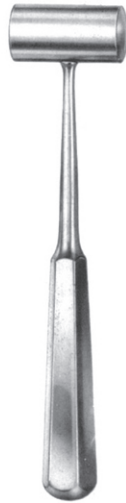

**Partsch**  
12-3502-18 18.0cm  
22mm Ø, 200 g (7 oz)



12-3503-30  
30mm Ø, 510 g

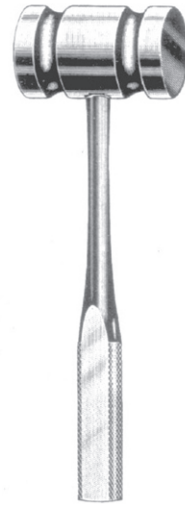

12-3504-25 250 g  
12-3505-45 450 g  
12-3506-90 900 g  
26.5cm

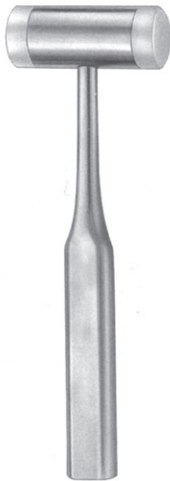

12-3507-18 18.5cm  
25mm Ø 135 g



lead filled

12-3508-19 19.0cm  
22mm Ø 155 g



**Hajek**  
12-3509-22 22.0cm  
27mm Ø 130 g

**BONE SURGERY**

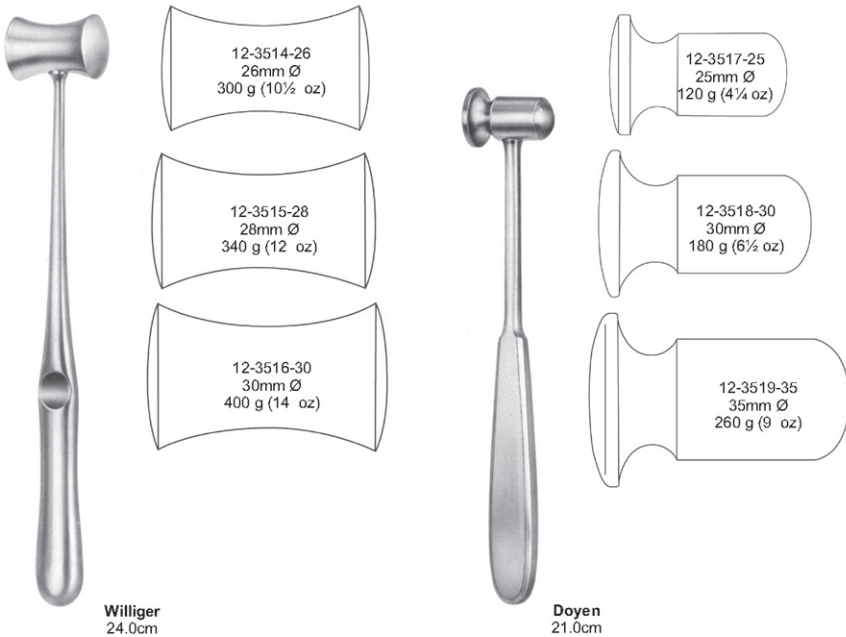
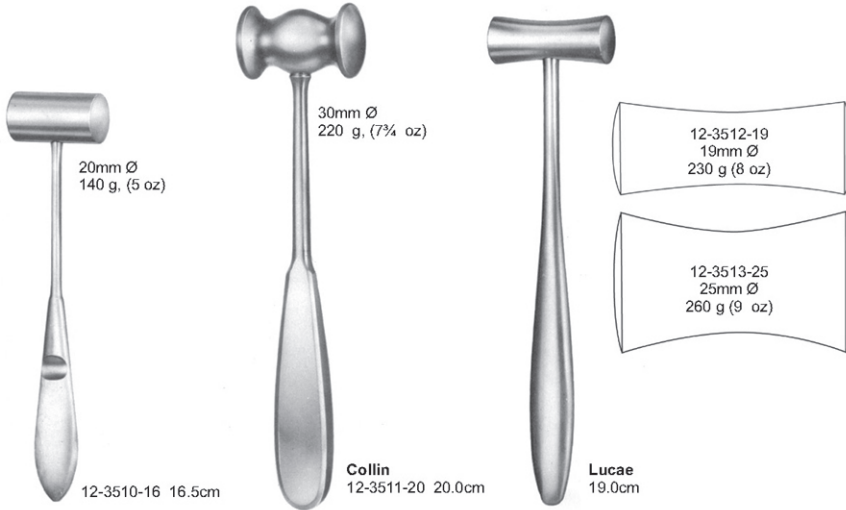

BONE SURGERY

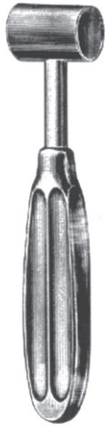

**Gerzog**  
12-3520-18 18.0cm  
250 g

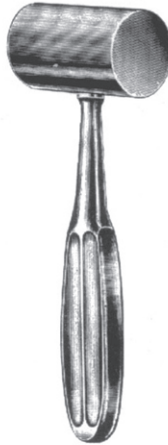

**Kirk**  
12-3521-19 19.0cm  
750 g

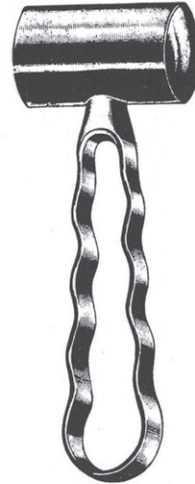

**Heath**  
18.0cm  
12-3522-35 35mm Ø (28 oz)  
12-3522-40 40mm Ø (36 oz)



12-3523-26  
26.5cm 530 g (19 oz)



12-3524-24  
24.0cm (30mm Ø 480 g)



12-3525-22  
22.5cm (37mm Ø 370 g)



12-3526-24 24.0cm

BONE SURGERY



12-3527-26 26.5cm  
 30mm Ø, 510 g (18 oz)



12-3528-26 26.5cm



12-3529-25 26.5cm 250 g (0.55 lbs)  
 12-3529-45 26.5cm 450 g (1 lbs)  
 12-3529-90 26.5cm 900 g (2 lbs)

BONE SURGERY



**Partsch**  
 mm 02 12-3530-02  
 03 12-3530-03  
 04 12-3530-04  
 05 12-3530-05  
 06 12-3530-06  
 07 12-3530-07  
 08 12-3530-08  
 13.5 cm/5¼"



**Partsch**  
 mm 02 12-3531-02  
 03 12-3531-03  
 04 12-3531-04  
 05 12-3531-05  
 06 12-3531-06  
 07 12-3531-07  
 08 12-3531-08  
 17 cm/6¾"



Width

**Partsch**  
 mm 04 12-3532-02  
 06 12-3532-03  
 08 12-3532-04  
 10 12-3532-05  
 12 12-3532-06  
 14 12-3532-07  
 16 12-3532-08  
 13.5 cm/5¼"



**Mod. USA**  
 mm 06 12-3537-06  
 12 12-3537-12  
 18 12-3537-18



**Mod. USA**  
 mm 12 12-3538-06  
 12 12-3538-12  
 18 12-3538-18  
 16 cm/6¼"



**Mod. USA**  
 mm 12 12-3539-06  
 12 12-3539-12  
 18 12-3539-18



16 cm/6¼"

- 12-3540-03 3mm
- 12-3540-05 5mm
- 12-3540-07 7mm
- 212-3540-09 9mm



**Passow**  
 12 cm/4¾"

- 12-3541-02 2.5mm
- 12-3541-03 3.5mm

BONE SURGERY



**Lexer**  
27.5 cm/10¾"

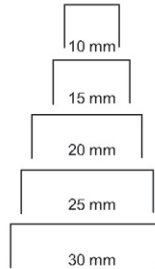

12-3542-10  
12-3542-15  
12-3542-20  
12-3542-25  
12-3542-30



12-3543-10  
12-3543-15  
12-3543-20  
12-3543-25  
12-3543-30



**Cloward**  
24 cm/9½"

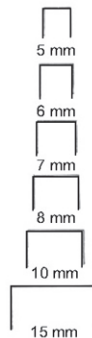

12-3544-05  
12-3544-06  
12-3544-07  
12-3544-08  
12-3544-10  
12-3544-15



12-3545-05  
12-3545-06  
12-3545-07  
12-3545-08  
12-3545-10  
12-3545-15

BONE SURGERY



**Alexander**  
18 cm/7"

	mm	
12-3546-04	04	12-3547-04
12-3546-06	06	12-3547-06
12-3546-08	08	12-3547-08
12-3546-10	10	12-3547-10
12-3546-12	12	12-3547-12
12-3546-14	14	12-3547-14

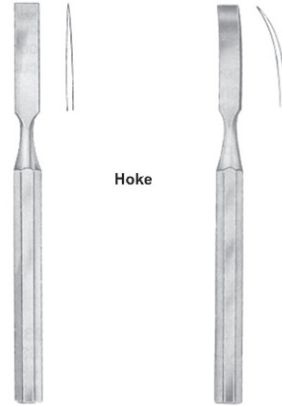

**Hoke**

14 cm/5½"

	mm	
12-3548-02	2	12-3549-02
12-3548-03	3	12-3549-03
12-3548-04	4	12-3549-04
12-3548-05	5	12-3549-05
12-3548-06	6	12-3549-06
12-3548-07	7	12-3549-07
12-3548-08	8	12-3549-08



**Smith-Petersen**  
20 cm/8"

	mm			
06	12-3550-06	12-3551-06	12-3552-06	12-3553-06
09	12-3550-09	12-3551-09	12-3552-09	12-3553-09
13	12-3550-13	12-3551-13		
14			12-3552-14	12-3553-14
16	12-3550-16	12-3551-16	12-3552-16	12-3553-16
19	12-3550-19	12-3551-19	12-3552-19	12-3553-19
25	12-3550-25	12-3551-25	12-3552-25	12-3553-25
32	12-3550-32	12-3551-32	12-3552-32	12-3553-32





**BONE SURGERY**



Curved



**Lambotte**

mm	
12-3554-04	04
12-3554-06	06
12-3554-08	08
12-3554-10	10
12-3554-13	13
12-3554-16	16
12-3554-18	18
12-3554-20	20
12-3554-25	25
12-3554-30	30
12-3554-38	38
12-3554-44	44
12-3554-50	50

24 cm/9½"

23 cm/9"



**Mini-Lambotte**

mm	
12-3556-02	02
12-3556-03	03
12-3556-04	04
12-3556-06	06
12-3556-08	08
12-3556-10	10
12-3556-12	12
12-3556-15	15

12.5 cm/5"

17 cm/6¾"



**Mini-Lexer**

mm	
12-3558-04	04
12-3558-06	06
12-3558-08	08
12-3558-10	10
12-3558-12	12

18 cm/7"



**Lexer**

mm	
12-3560-05	05
12-3560-07	07
12-3560-10	10
12-3560-15	15
12-3560-20	20
12-3560-25	25
12-3560-30	30

22 cm/8¾"



BONE SURGERY



**Chisel**  
12-3562-20  
24.5 cm/9 3/4"  
20 mm



**Chisel-Curved**  
12-3563-20  
26.5 cm/10 1/2"  
20 mm

Gouge for the  
removing of  
broken screws



12-3564-22  
22 cm/8 3/4"



BONE SURGERY



**Zielke**  
 23 cm/9"  
 5.5 mm 12-3565-05  
 9.0 mm 12-3565-09



Width

mm	12-3566-06	12-3567-06	12-3568-06	12-3569-06	12-3570-06
06	12-3566-06	12-3567-06	12-3568-06	12-3569-06	12-3570-06
08	12-3566-08	12-3567-08	12-3568-08	12-3569-08	12-3570-08
10	12-3566-10	12-3567-10	12-3568-10	12-3569-10	12-3570-10
12	12-3566-12	12-3567-12	12-3568-12	12-3569-12	12-3570-12
15	12-3566-15	12-3567-15	12-3568-15	12-3569-15	12-3570-15
20	12-3566-20	12-3567-20	12-3568-20	12-3569-20	12-3570-20
25	12-3566-25	12-3567-25	12-3568-25	12-3569-25	12-3570-25
30	12-3566-30	12-3567-30	12-3568-30	12-3569-30	12-3570-30



mm	12-3571-06	12-3572-06	12-3573-06	12-3574-06	12-3575-06
06	12-3571-06	12-3572-06	12-3573-06	12-3574-06	12-3575-06
09	12-3571-09	12-3572-09	12-3573-09	12-3574-09	12-3575-09
13	12-3571-13	12-3572-13	12-3573-13	12-3574-13	12-3575-13
16	12-3571-16	12-3572-16	12-3573-16	12-3574-16	12-3575-16
19	12-3571-19	12-3572-19	12-3573-19	12-3574-19	12-3575-19
25	12-3571-25	12-3572-25	12-3573-25	12-3574-25	12-3575-25
32	12-3571-32	12-3572-32	12-3573-32	12-3574-32	12-3575-32

**Hibbs**  
 24 cm/9½"

BONE SURGERY



mm **Lexer**  
05 12-3576-05  
10 12-3576-10  
15 12-3576-15  
  
28 cm/11"



**Lexer**  
12-3577-05  
12-3577-10  
12-3577-15  
  
25 cm/10"



**Lexer**  
12-3578-05  
12-3578-10  
12-3578-15  
  
25 cm/10"



12-3579-01



12-3579-02



12-3579-03

**Cobb**  
28 cm/11"



12-3579-04

BONE SURGERY



**Putti**  
12-3580-30  
30 cm/12"



**Putti**  
12-3581-27  
27 cm/10½"



12-3582-25  
25 cm/10"



12-3583-24  
24 cm/9½"



12-3584-22  
22 cm/8¾"



BONE SURGERY



**Lambotte**  
21 cm/8¼"

Width

	mm
12-3585-05	05
12-3585-10	10
12-3585-15	15
12-3585-20	20
12-3585-25	25



**Schneider**  
12-3586-17  
13 mm  
17.5 cm/7"



**Schneider-Sauerbruch**  
12-3587-19  
13 mm  
19 cm/7½"



**Alexander**  
12-3588-20  
20 cm/8"



**Jansen**  
12-3589-16  
15 mm  
16.5 cm/6½"



**Seldin**  
12-3590-19  
19 cm/7½"



**Davidson-Alexander**  
12-3591-29  
29 cm/11½"



**Williger**  
12-3592-29  
13 cm/5"

BONE SURGERY

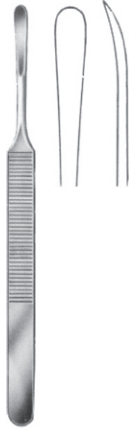

**König**  
12-3593-15  
15.5 cm/6"  
5 mm



**Williger**  
12-3594-16  
16 cm/6 1/4"



**Adson**  
17 cm/6 3/4"



12-3596-06 6 mm  
17 cm/6 3/4"  
12-3597-08 8 mm

BONE SURGERY



**Farabeuf**  
12-3598-15  
15 cm/6"



**Farabeuf**  
12-3599-15  
15 cm/6"



**Farabeuf-Collin**  
12-3600-15  
15.5 cm/6"  
11 mm



**Farabeuf-Collin**  
12-3601-15  
15.5 cm/6"  
11 mm



**Farabeuf**  
12-3602-19  
19 cm/7 1/2"  
13 mm

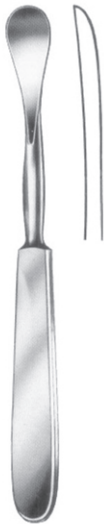

**Sedillot**  
12-3603-18  
18 cm/7"  
18 mm



**Sedillot**  
12-3604-21  
21 cm/8 1/4"  
15 mm



**Langenbeck**  
12-3605-19  
19 cm/7 1/2"



**Langenbeck**  
12-3606-18  
18 cm/7"



BONE SURGERY



**Overholt**  
12-3607-29  
29.5 cm/11½"



**Overholt**  
12-3608-29  
29.5 cm/11½"



**Overholt**  
12-3609-28  
28.5 cm/11¼"



**Hylin**  
14.5 cm/5¾"



12-3610-01



12-3610-02



12-3610-03



**Matson**  
12-3611-22  
22 cm/8¾"

**BONE SURGERY**



**Semb**



12-3612-01  
19.5 cm/7 1/2"  
12 mm

12-3613-02  
19.5 cm/7 1/2"  
12 mm

12-3614-03  
19.5 cm/7 1/2"  
12 mm

12-3615-04  
22 cm/8 3/4"  
13 mm

12-3616-05  
21.5 cm/8 1/2"  
13 mm

12-3617-06  
22 cm/8 1/2"  
15 mm

12-3618-07  
22 cm/8 1/2"  
15 mm



**Doyen**  
17 cm/6 3/4"

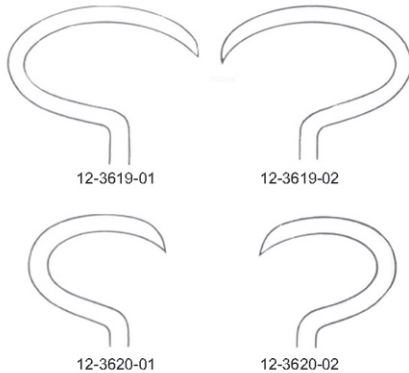

12-3619-01

12-3619-02

12-3620-01

12-3620-02



**Doyen**  
24 cm/9 1/2" 12-3622-02

BONE SURGERY



12-3623-04  
4 mm



12-3623-06  
6 mm



12-3623-08  
8 mm



**Cobb**  
24 cm/9½"



12-3623-10  
10 mm



12-3623-13  
13 mm



12-3623-19  
19 mm



12-3623-25  
25 mm

BONE SURGERY



12-3624-01  
 19 cm/7 1/2"  
 6 mm



12-3625-02  
 18.5 cm/7 1/4"  
 3 mm



12-3626-03  
 18.5 cm/7 1/4"  
 6 mm



12-3627-04  
 18.5 cm/7 1/4"  
 6 mm

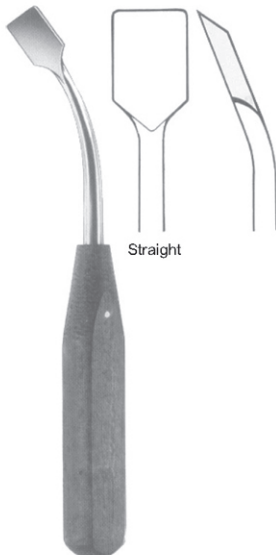

12-3628-05  
 18.5 cm/7 1/4"  
 13 mm



12-3629-06  
 19.5 cm/7 3/4"  
 14 mm



12-3630-07  
 18.5 cm/7 1/4"  
 14 mm



12-3631-08  
 20 cm/8"  
 20 mm

BONE SURGERY



12-3632-20  
 27.5 cm/10¾"  
 20 mm



**Wagner**

8 mm 12-3633-08 33 cm/13"  
 17 mm 12-3633-17 33 cm/13"



**Cobb**

10 mm 12-3634-10 25 cm/10"  
 13 mm 12-3634-13 25 cm/10"  
 19 mm 12-3634-19 25 cm/10"  
 25 mm 12-3634-25 25 cm/10"



**Cobb**

10 mm 12-3635-10 28 cm/11"  
 13 mm 12-3635-13 28 cm/11"  
 19 mm 12-3635-19 28 cm/11"

BONE SURGERY



**Hoen**

12-3636-07  
 16 cm/6¼"  
 7 mm

12-3636-15  
 18.5 cm/7¼"  
 15 mm

12-3636-20  
 19 cm/7½"  
 20 mm



**Yankauer**  
 12-3637-18  
 18 cm/7"



**Langenbeck**  
 12-3638-20  
 20 cm/8"  
 8 mm



**Langenbeck**  
 12-3639-20  
 20 cm/8"  
 10 mm



**Langenbeck**  
 12-3640-23  
 23 cm/9"  
 11 mm



**Mass. Gen. Hosp.**  
 12-3641-15  
 15 cm/6"



**Williger**  
 12-3642-17  
 17 cm/6¾"  
 5.5 mm



**Williger**  
 12-3643-16  
 16 cm/6¼"



**Quervain**  
 12-3644-20  
 20 cm/8"

BONE SURGERY



12-3645-16  
 16 cm/6 1/4"

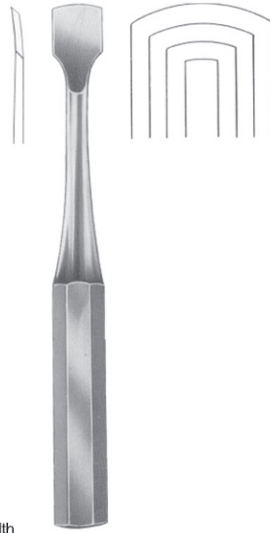

Width  
**Key**  
 6 mm 12-3646-06 19 cm/7 1/2"  
 12 mm 12-3646-12 19 cm/7 1/2"  
 19 mm 12-3646-19 19 cm/7 1/2"  
 25 mm 12-3646-25 19 cm/7 1/2"



**König**  
 12-3647-15  
 15 cm/6"  
 4.5 mm



**König**  
 12-3648-15  
 15 cm/6"  
 4.5 mm



**Alderdyce**  
 12-3649-21  
 21 cm/8 1/4"



**McDonald**  
 12-3650-19  
 19 cm/7 1/2"



**Watson-Cheyne**  
 12-3651-19  
 17.5 cm/7"



**Sebileau**  
 12-3652-17  
 17 cm/6 3/4"

BONE SURGERY



12-3653-14  
14 cm/5½"  
2.8 mm



12-3654-15  
15 cm/6"  
5 mm



12-3655-15  
15 cm/6"  
7 mm

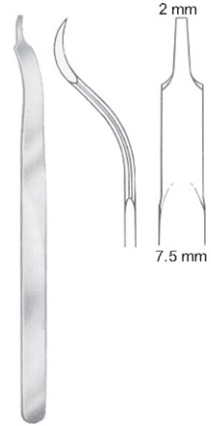

**Buck-Gramcko**  
12-3656-15  
15 cm/6"

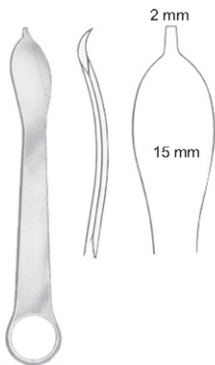

12-3657-12  
12.5 cm/5"



**Mini-Hohmann**  
12-3658-06  
16 cm/6¼"  
6 mm



12-3658-08  
8 mm





BONE SURGERY



12-3659-17  
17 mm

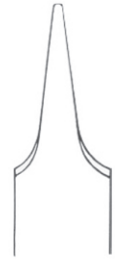

12-3660-17  
17 mm



12-3661-26  
26.5 cm/10½"  
24 mm



**Lange-Hohmann**  
12-3662-26  
26 cm/10¼"  
22 mm



**Hohmann**  
12-3663-22  
22 cm/8¾"  
8 mm



**Hohmann**  
12-3664-24  
24 cm/9½"  
14 mm

BONE SURGERY



**Hohmann**  
 12-3665-26  
 26 cm/10 1/4"  
 22 mm

**Hohmann**  
 12-3666-28  
 28 cm/11"  
 33 mm

**Hohmann**  
 12-3667-24  
 24 cm/9 1/2"  
 43 mm

**Hohmann**  
 12-3668-24  
 24.5 cm/9 3/4"  
 43 mm

**Hohmann**  
 12-3669-24  
 24 cm/9 1/2"  
 70 mm

**Hohmann**  
 12-3670-22  
 22 cm/8 3/4"  
 18 mm

## BONE SURGERY



**Lange-Hohmann modif**  
 30 mm 12-3671-26 26.5 cm/10½"  
 33 mm 12-3671-29 29.0 cm/11½"

**Hohmann-Aldinger**  
 12-3672-27  
 27 cm/10½"

**Schumacher**  
 (Wagner)  
 12-3673-34  
 34.5 cm/13½"

**Schumacher**  
 12-3674-29  
 29 cm/11½"

BONE SURGERY



**Smillie**  
14 cm/5½"

12-3675-01  
32x19 mm

12-3675-02  
48x19 mm

12-3675-03  
57x19 mm



12-3675-04  
52x13 mm



12-3675-05  
12x13 mm

Spinal retractors



12-3676-01  
75x30 mm

12-3676-02  
100x30 mm

**Taylor**  
17 cm/6½"



12-3677-21  
21.5 cm/8½"

Meniscus retractors



**Blount**  
12-3678-17  
17.5 cm/7"

## BONE SURGERY



**Murphy-Lane**  
12-3679-32  
32 cm/12½"



**Chandler**

Length	Width	
18 cm	13 mm	12-3680-13
20 cm	19 mm	12-3680-19
23 cm	25 mm	12-3680-23
25 cm	30 mm	12-3680-30



**Blount**  
12-3681-26  
26 cm/10¼"



**Blount**  
12-3682-26  
26 cm/10¼"



**Bennett**  
12-3683-44 44 mm  
12-3683-64 64 mm

**BONE SURGERY**



**Smillie**  
12-3684-17  
17 cm/6 3/4"



**Smillie**  
12-3685-17  
17 cm/6 3/4"



**Smillie**  
12-3686-17  
17 cm/6 3/4"



**Salenius**  
12-3687-22  
22 cm/8 3/4"



**Salenius**  
12-3688-22  
22 cm/8 3/4"



12-3689-17  
17.5 cm/7"



**Neff**  
12-3690-21  
21.5 cm/8 1/2"



**Canad-Modell**  
12-3691-01  
20 cm/8"



12-3692-02



**Bircher**  
12-3693-20  
20.5 cm/8"

**BONE SURGERY**

Drill guide and dura protecting forceps



**Adson**  
12-3694-15  
15 cm/6"

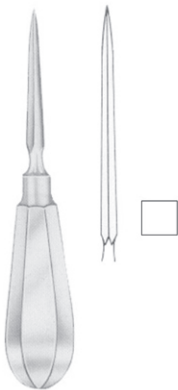

12-3695-14  
14 cm/5½"



**Perthes**  
12-3696-21  
21 cm/8 ¼"

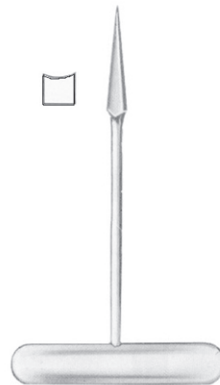

12-3697-14  
14 cm/5½"

**BONE SURGERY**

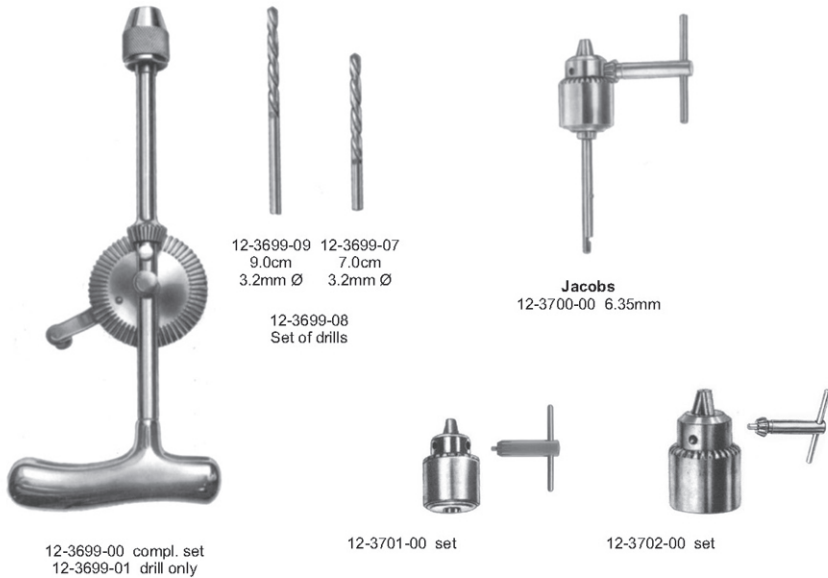
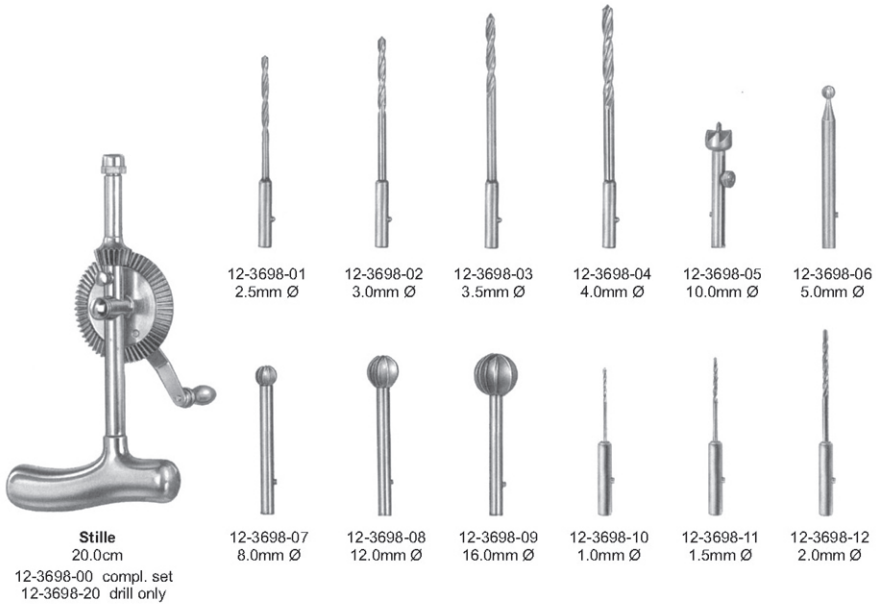



BONE SURGERY



**Stille-Sherman**  
24.0cm  
12-3703-00 compl. set  
12-3703-24 drill only



12-3703-25  
2.5mm Ø



12-3703-30  
3.0mm Ø



12-3703-35  
3.5mm Ø



**Hudson**  
12-3704-00 compl. set / 6  
(12-3704,01,  
02,03,07,09)  
12-3704-27  
handle only



12-3704-01  
9mm Ø



12-3704-02  
14mm Ø



12-3704-03  
16mm Ø



12-3704-04  
22mm Ø



**Cushing**  
12-3704-05  
14mm Ø



12-3704-06  
2mm Ø



**Mckenzie**  
12-3704-07  
13mm Ø



**Errico**  
12-3704-08  
16mm Ø



12-3704-09

BONE SURGERY

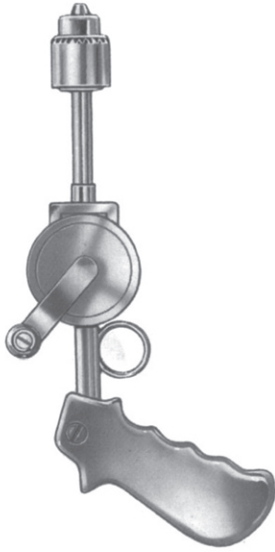

12-3705-00



12-3706-00



12-3707-00

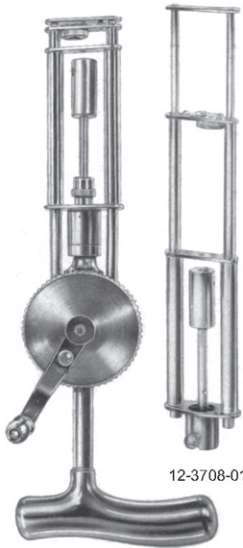

12-3708-01

12-3708-00 complete set



12-3709-01

12-3709-02

12-3709-03

**Kirschner**  
12-3709-00 complete set

BONE SURGERY

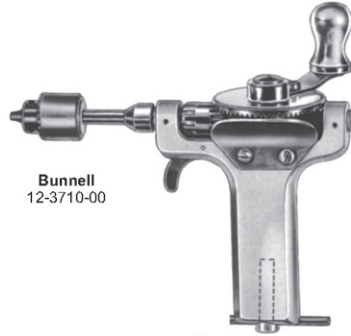

**Bunnell**  
 12-3710-00



**Ralk**  
 12-3711-00

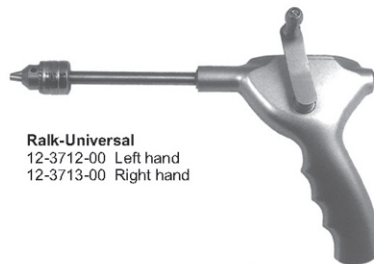

**Ralk-Universal**  
 12-3712-00 Left hand  
 12-3713-00 Right hand

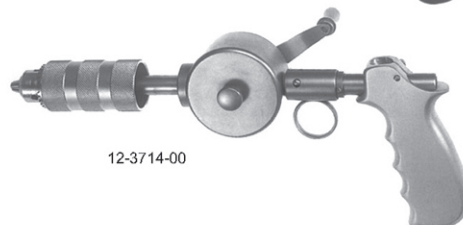

12-3714-00

BONE SURGERY



**Spare Saw Blade**  
12-3715-12 12mm  
12-3715-15 15mm  
12-3715-18 18mm



**Chaarriere**  
12-3715-35 35.0cm



**Spare Saw Blade**  
12-3716-03 3mm  
12-3716-05 5mm  
12-3716-07 7mm



**Helferich-Bier**  
12-3716-39 39.0cm



**Lindemann**  
12-3717-20 20.0cm



**Langenbeck**  
12-3718-23 23.0cm

12-3719-06 6mm  
12-3719-08 8mm  
12-3719-12 12mm  
12-3719-15 15mm  
12-3719-18 18mm



**Rust**  
12-3719-39 39.0cm

## BONE SURGERY



**Charriere**  
 12-3720-27 27.0cm  
 12-3720-30 30.0cm  
 12-3720-34 34.0cm



**Satterlee**  
 12-3721-31 31.0cm



**Charriere**  
 12-3722-27 27.0cm  
 12-3722-30 30.0cm



**Satterlee**  
 12-3723-31  
 31.0cm



12-3724-23  
 23.0cm

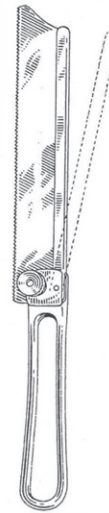

12-3725-19  
 19.0cm

BONE SURGERY

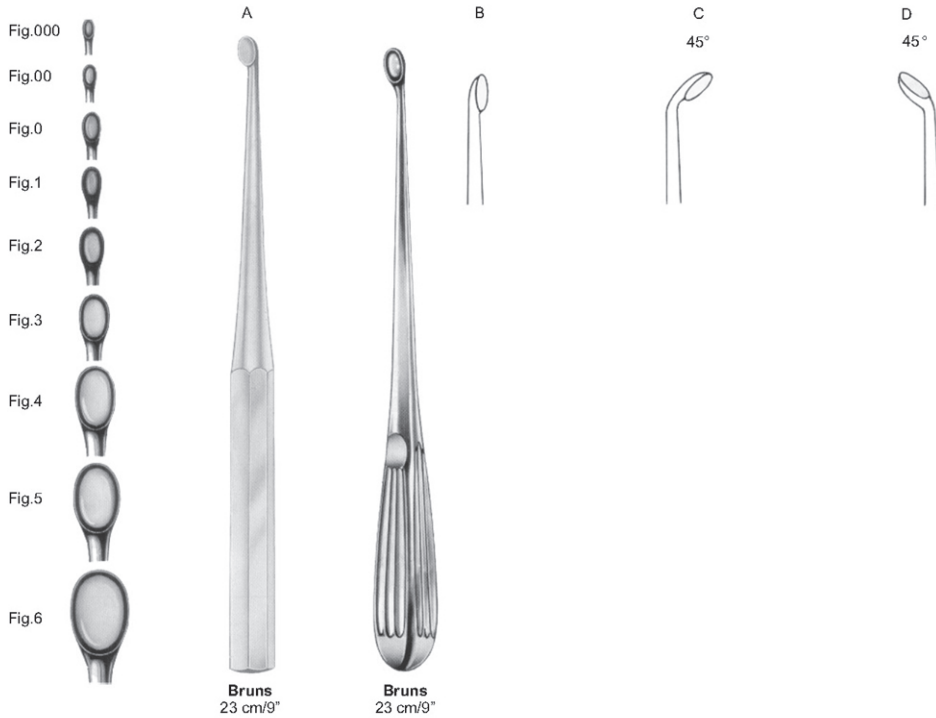
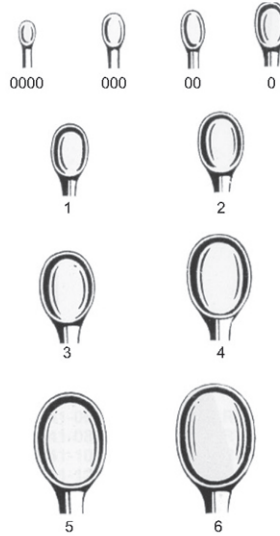

Fig.	A	B	C	D
000	12-3726-30	12-3727-30	12-3728-30	12-3729-30
00	12-3726-20	12-3727-20	12-3728-20	12-3729-20
0	12-3726-10	12-3727-10	12-3728-10	12-3729-10
1	12-3726-01	12-3727-01	12-3728-01	12-3729-01
2	12-3726-02	12-3727-02	12-3728-02	12-3729-02
3	12-3726-03	12-3727-03	12-3728-03	12-3729-03
4	12-3726-04	12-3727-04	12-3728-04	12-3729-04
5	12-3726-05	12-3727-05	12-3728-05	12-3729-05
6	12-3726-06	12-3727-06	12-3728-06	12-3729-06

BONE SURGERY



**Volkmann**  
 17 cm/6¾"



- Fig.  
 0000 12-3730-40  
 000 12-3730-30  
 00 12-3730-20  
 0 12-3730-10  
 1 12-3730-01  
 2 12-3730-02  
 3 12-3730-03  
 4 12-3730-04  
 5 12-3730-05  
 6 12-3730-06



**Volkmann**  
 17 cm/6¾"

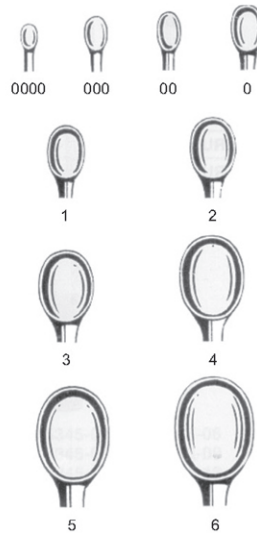

- Fig.  
 0000 12-3731-40  
 000 12-3731-30  
 00 12-3731-20  
 0 12-3731-10  
 1 12-3731-01  
 2 12-3731-02  
 3 12-3731-03  
 4 12-3731-04  
 5 12-3731-05  
 6 12-3731-06

BONE SURGERY



12-3732-21  
21 cm/8 1/4"



Epstein



Spinal



Spinal

Fig.			
000	12-3733-30	12-3734-30	12-3735-30
00	12-3733-20	12-3734-20	12-3735-20
0	12-3733-10	12-3734-10	12-3735-10
1	12-3733-01	12-3734-01	12-3735-01
2	12-3733-02	12-3734-02	12-3735-02
3	12-3733-03	12-3734-03	12-3735-03
4	12-3733-04	12-3734-04	12-3735-04
5	12-3733-05	12-3734-05	12-3735-05
6	12-3733-06	12-3734-06	12-3735-06
	20 cm/8"	20 cm/8"	20 cm/8"



**BONE SURGERY**



	<b>Volkman</b>	<b>Volkman</b>	
Length	Oval/Oval	Oval/Round	
cm			
in			
13	5"	12-3736-13	12-3737-13
14	5½"	12-3736-14	
16	6¼"		12-3737-16
17	6¾"	12-3736-17	
20	8"	12-3736-20	12-3737-20

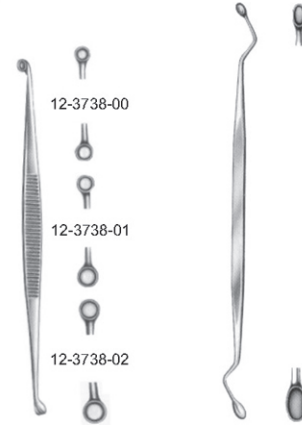

**Martini**  
13.5 cm/5"

**Jansen**  
12-3739-15  
15 cm/6"



**Jansen**  
12-3740-16  
16 cm/6¼"



**Williger**  
13.5 cm/5"



**Jacobson**  
12-3742-13  
13 cm/5"



**Janson**  
12-3743-15  
15 cm/6"



**Barth**  
12-3744-18  
18 cm/7"

BONE SURGERY

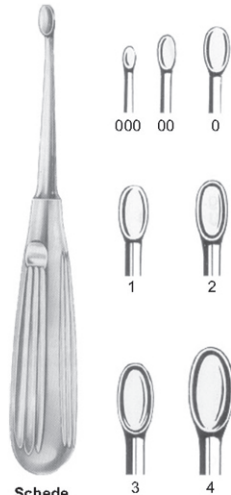

**Schede**  
17 cm/6¾"

Fig.	
000	12-3745-30
00	12-3745-20
0	12-3745-10
1	12-3745-01
2	12-3745-02
3	12-3745-03
4	12-3745-04

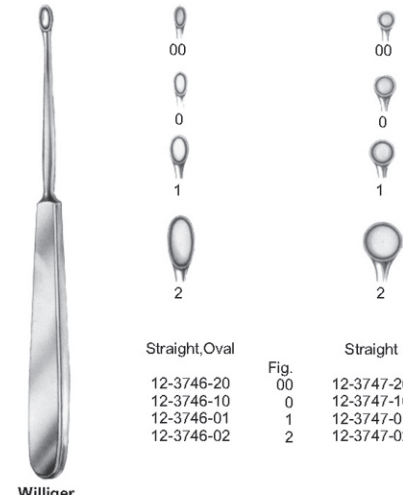

**Williger**  
17.5 cm/7"

<b>Straight, Oval</b>		<b>Straight</b>	
Fig.		Fig.	
00	12-3746-20	00	12-3747-20
0	12-3746-10	0	12-3747-10
1	12-3746-01	1	12-3747-01
2	12-3746-02	2	12-3747-02

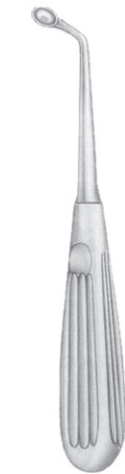

12-3748-01

**Uffenorde**  
17 cm/6¾"

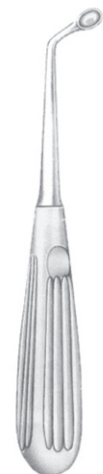

12-3749-02

BONE SURGERY

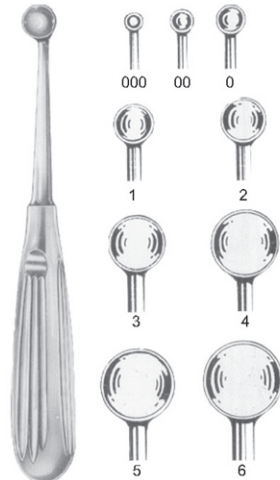

**Brun's**  
17 cm/6¾"

Brun's	Fig.	Spratt
12-3750-30	000	12-3751-30
12-3750-20	00	12-3751-20
12-3750-10	0	12-3751-10
12-3750-01	1	12-3751-01
12-3750-02	2	12-3751-02
12-3750-03	3	12-3751-03
12-3750-04	4	12-3751-04
12-3750-05	5	12-3751-05
12-3750-06	6	12-3751-06

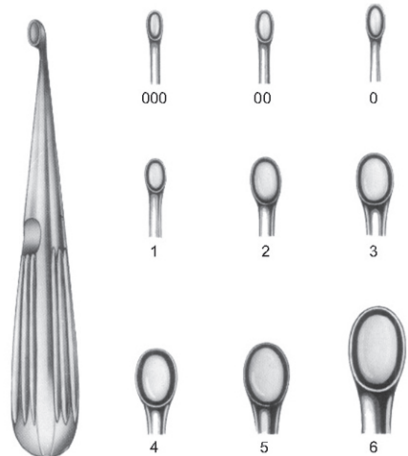

**Spratt**  
16 cm/6¼"



Swedish pattern

mm	Round	Oval
2	12-3752-02	12-3753-02
3	12-3752-03	12-3753-03
4	12-3752-04	12-3753-04
5	12-3752-05	12-3753-05
6	12-3752-06	12-3753-06
7	12-3752-07	12-3753-07
8	12-3752-08	12-3753-08
10	12-3752-10	12-3753-10
12	12-3752-12	12-3753-12
14	12-3752-14	12-3753-14
	17 cm/6¾"	22 cm/8½"

BONE SURGERY

Flexible

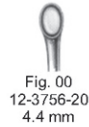
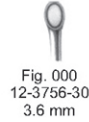

BONE SURGERY

Fig. 0  
12-3758-10

Fig. 1  
12-3759-01

Fig. 4  
12-3759-04

Fig. 0000  
12-3760-40

Fig. 00  
12-3761-20

Fig. 1  
12-3758-01

Fig. 2  
12-3759-02

Fig. 5  
12-3759-05

Fig. 000  
12-3760-30

Fig. 0  
12-3761-10

Fig. 2  
12-3758-02

Fig. 3  
12-3759-03

Fig. 6  
12-3759-06

Fig. 00  
12-3760-20

Fig. 1  
12-3761-01

Fig. 3  
12-3758-03

Fig. 0  
12-3760-10

Fig. 2  
12-3761-02



**Volkmann**  
27 cm/10½"



**Simon**  
24 cm/9½"



**Simon**  
24 cm/9½"



**Daubenspeck**  
20 cm/8"

BONE SURGERY



**Martin**  
12-3762-19  
19 cm/7½"



**Preston**  
12-3763-18  
18 cm/7¼"

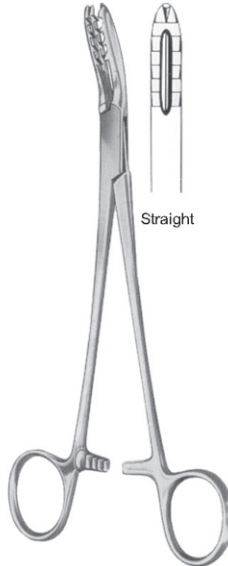

**Bircher-Ganske**  
12-3764-20  
20 cm/8"



**Bircher-Ganske**  
12-3765-20  
20 cm/8"



**Lewin**  
12-3766-17  
17.5 cm/7"



**Langenbeck**  
12-3767-21  
21 cm/8¼"



**Fergusson**  
12-3768-21  
21 cm/8¼"

**BONE SURGERY**

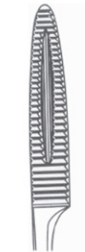

**Straight**  
 12-3769-20  
 20 cm/8"



**Curved on Fallt**  
 12-3770-20  
 20 cm/8"



**Van Buren**  
 12-3771-23  
 23 cm/9"



**Dingmann**  
 12-3772-19  
 19cm/7½"



**Dingmann Modif**  
 12-3773-19  
 19 cm/7½"



**Neff**  
 12-3774-21  
 21 cm/8¼"

BONE SURGERY



**Semb**  
12-3775-19  
19 cm/7½"



**Semb**  
12-3776-19  
19 cm/7½"



**Verbrugge**  
12-3777-17  
17.5 cm/7"

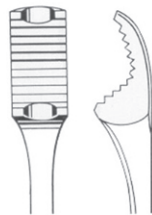

12-3778-25  
25 cm/10"

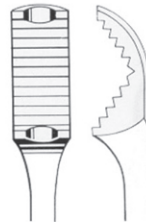

12-3779-26  
26 cm/10¼"  
**Verbrugge**

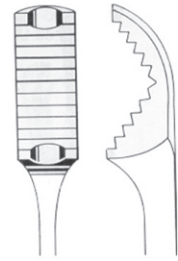

12-3780-27  
27 cm/10½"



## BONE SURGERY



12-3781-16  
 16 cm/6¼"  
 12-3781-24  
 24 cm/9½"



Without Ratchet	Kern	With Ratchet
12-3782-17	cm 17 in 6¾"	12-3783-17
12-3782-21	cm 21 in 8¼"	12-3783-21



12-3784-18	18 cm/07"	12-3785-18
12-3784-23	23 cm/09"	12-3785-23
12-3784-25	25 cm/10"	12-3785-25
12-3784-28	28 cm/11"	12-3785-28



**Hey Groves**  
 12-3786-21 21.0 cm/8¼"  
 12-3786-27 27.0 cm/10½"  
 12-3786-30 30.5 cm/12"

BONE SURGERY



**Farabeuf-Lambotte**  
12-3787-26  
26 cm/10¼"



**Lambotte**  
12-3788-19 19 cm/7½"  
12-3788-23 23 cm/9"  
12-3788-26 26 cm/10¼"



<b>Without Ratchet</b>	<b>Lane</b>	<b>With Ratchet</b>
12-3789-33	cm in	12-3790-33
12-3789-45	33 13"	45 17¾"
		12-3790-45



12-3791-14  
14.5 cm/5¾"



12-3792-12  
12 cm/4¾"

BONE SURGERY



12-3793-15 15 cm/6"  
 12-3793-19 19 cm/7 1/2"  
 12-3793-24 24 cm/9 1/2"  
 12-3793-26 26 cm/10 1/4"  
 12-3793-28 28 cm/11"

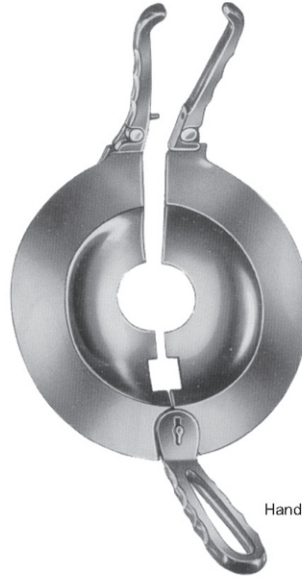

Handles Detachable

**Percy**  
 12-3794-30

Adjustable



**Lambotte**  
 12-3795-22 22 cm/8 3/4"  
 12-3795-27 27 cm/10 1/2"  
 12-3795-30 30 cm/12"



**Farabeuf**  
 12-3796-23 23 cm/9"  
 12-3796-26 26 cm/10 1/4"



**Lambotte**  
 12-3797-22 22.5 cm/9"  
 12-3797-25 25.5 cm/10 1/2"  
 12-3797-33 33 cm/13 1/2"

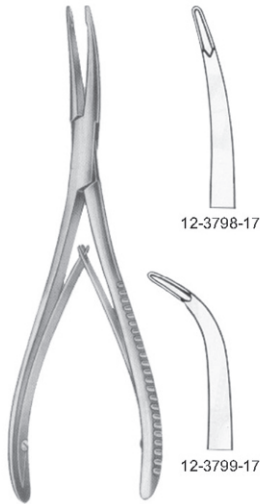

**Stellbrink**  
17.5 cm/7"



**Bane-Hartmann**  
12-3800-17  
17.5 cm/7"



**Mini-Friedmann**  
12-3801-12  
12.5 cm/5"



**Friedmann**  
12-3802-14  
14 cm/5½"

BONE SURGERY



12-3803-13  
13.5 cm/5 1/4"



12-3804-20  
20 cm/8"



12-3805-17  
17 cm/6 3/4"

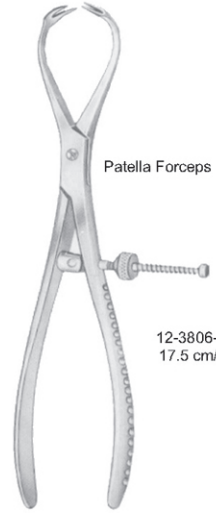

Patella Forceps

12-3806-17  
17.5 cm/7"



Lowman-Hoglund  
12-3807-19  
19 cm/7 1/2"



Lowman  
12-3808-18 18 cm/7"  
12-3808-20 20 cm/8"  
12-3808-22 22 cm/8 3/4"



Lowman  
12-3809-12  
12 cm/4 3/4"

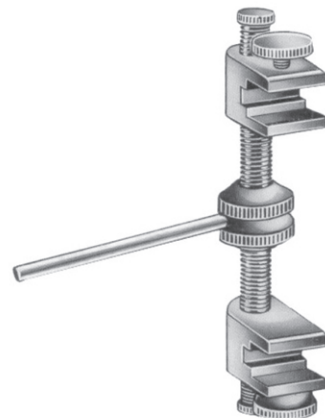

Traction Bar

12-3810-18  
12-3810-50

BONE SURGERY

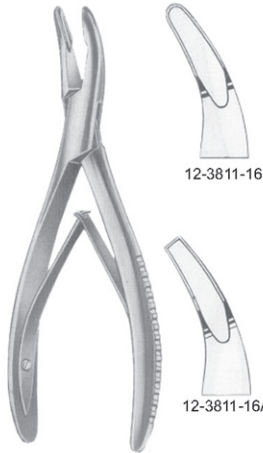

**Mead**  
16.5 cm/6½"

12-3811-16

12-3811-16A



**Lempert**  
Straight      cm    in  
12-3812-16    16   6¼"    12-3813-16  
12-3812-19    19   7½"    12-3813-19



**Beyer**  
12-3814-18  
18 cm/7"



**Jansen**  
17.5 cm/7"

12-3815-17

12-3816-17

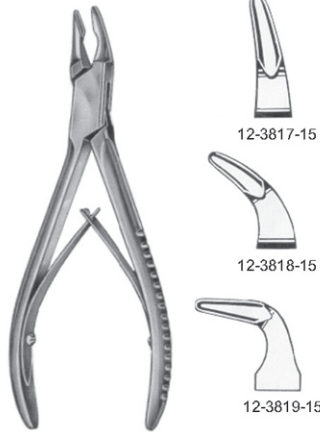

**Blumenthal**  
15.5 cm/6"

12-3817-15

12-3818-15

12-3819-15



**Hakansson**  
12-3820-15  
15.5 cm/6"

**BONE SURGERY**



**Friedmann-Delicate**  
 15 cm/6"



**Bacon**  
 12-3823-20  
 20 cm/8"



**Cleveland**  
 12-3824-14 14 cm/5½"  
 12-3824-17 17 cm/6¾"



**Hartmann**  
 12-3825-18  
 18.5 cm/7¼"



**Olivecrona**  
 12-3826-20  
 20 cm/8"

**BONE SURGERY**



**Kleinert-Kutz**  
15 cm/6"



12-3827-15  
2 mm



12-3828-15  
3 mm



**Bohler**  
15 cm/6"



12-3829-15



12-3830-15



**Beyer Zaufal-Jansen**  
18 cm/7"



**Zaufal-Jansen**  
12-3831-18



**Beyer**  
12-3832-18



**Mayfield**  
12-3833-17  
17 cm/6 3/4"



**Ruskin**  
12-3834-18  
18 cm/7"  
Angled



**Straight**  
12-3835-18  
18 cm/7"  
12-3835-23  
23 cm/9"



**Ruskin**

**Curved**  
12-3836-18  
18 cm/7"  
12-3836-23  
23 cm/9"



- EN —
- DE —
- ES —

Bone Rongeur Forceps  
 Hohlmeißelzangen  
 Pinzas-gubias

**BONE SURGERY**



**Jansen**  
 12-3837-18  
 18 cm/7"



**Straight**  
 12-3838-17

**Curved**  
 12-3839-17

**Luer**  
 17 cm/6¾"



**Luer**  
 18.5 cm/7¼"

Heavy Pattern

**Straight**  
 12-3840-18

**Curved**  
 12-3841-18



**Luer**  
 15 cm/6"



12-3842-15

12-3843-15

12-3844-15



**Adson**  
 20 cm/8"



12-3845-20

BONE SURGERY



**Stille-Luer**  
22 cm/8¾"



**Straight**  
12-3846-22



**Curved**  
12-3847-22



**Stille-Luer**  
27 cm/10½"



12-3848-27



12-3849-27



**Semb**  
12-3850-23  
23 cm/9"

- EN —
- DE —
- ES —

Bone Rongeur Forceps  
 Hohlmeißelzangen  
 Pinzas-gubias

BONE SURGERY



**Marquardt**  
 12-3851-20  
 20 cm/8"



**Rottgen-Ruskin**  
 12-3852-24  
 24 cm/9½"



12-3853-03  
 3 mm



12-3853-04  
 4 mm



12-3853-05  
 5 mm



12-3853-03A  
 3 mm



12-3853-04A  
 4 mm



12-3853-05A  
 5 mm



**Smith-Petersen**  
 24 cm/9 ½"

BONE SURGERY



**Markwalder**  
12-3854-20  
20 cm/8"



**Straight**  
12-3855-14  
12-3855-17  
12-3855-19  
12-3855-22

cm  
14  
17  
19  
22



**Liston** in  
5 1/2  
6 3/4  
7 1/2  
8 3/4

**Curved**  
12-3856-14  
12-3856-17  
12-3856-19  
12-3856-22



**Littauer-Liston**  
12-3857-15  
15 cm/6"



**Cleveland**  
12-3858-15 15 cm/6"  
12-3858-17 17 cm/6 3/4"



**Bohler**  
15 cm/6"



**Straight**  
12-3859-15



**Curved on flat**  
12-3860-15



**McIndoe**  
12-3861-17  
17.5 cm/7"

BONE SURGERY



**Stille-Ruskin**  
12-3862-23  
23 cm/9"

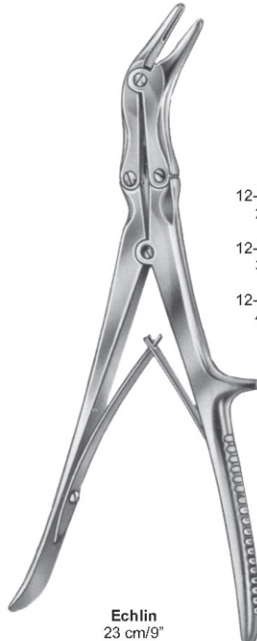

**Echlin**  
23 cm/9"

- 12-3863-02  
2 mm
- 12-3863-03  
3 mm
- 12-3863-04  
4 mm



**Leksell**  
23 cm/9"

- 12-3864-03  
3 mm
- 12-3864-04  
4 mm
- 12-3864-06  
6 mm
- 12-3864-08  
8 mm



**Frykholm**  
12-3865-23  
23 cm/9"



**Stille**  
12-3866-23  
23 cm/9"

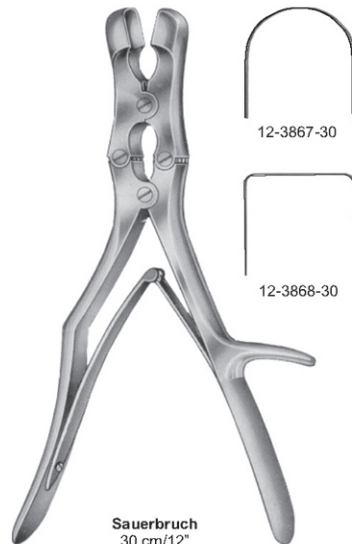

**Sauerbruch**  
30 cm/12"

- 12-3867-30
- 12-3868-30

BONE SURGERY



12-3869-13  
13.5 cm/5"



18 cm/7"

Forceps for tearing out toe and finger nails



12-3870-18

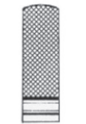

12-3871-18



12-3872-13  
13.5 cm/5 1/4"

Saw blade



12-3873-17  
17 cm/6 3/4"



12-3874-17  
17 cm/6 3/4"

Saw blade

BONE SURGERY



**Kazanjian**  
 12-3875-18  
 18 cm/7"



**Ruskin-Liston**  
 18.5 cm/7 1/4"



Straight  
 12-3876-18



Curved on flat  
 12-3877-18



**Stille-Liston**  
 23 cm/9"  
 27 cm/10 1/2"

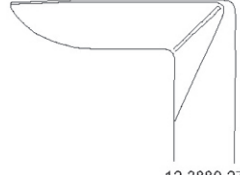

12-3880-27  
 27 cm/10 1/2"

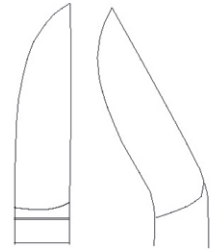

12-3878-23      12-3879-23  
 27 cm/10 1/2"      27 cm/10 1/2"



**Liston-Key(Horsley)**  
 12-3881-27  
 27 cm/10 1/2"



**Semb**  
 12-3882-24  
 24 cm/9 1/2"

BONE SURGERY



12-3883-13 13 cm/5"  
12-3883-18 18 cm/7"

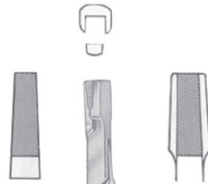

12-3884-17  
17 cm/6¾"

TC

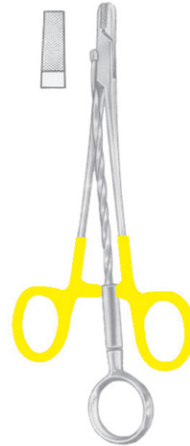

12-3885-15  
15.5 cm/6"



12-3886-17 17 cm/6¾" 12-3887-17



12-3888-19  
19 cm/7 ½"



BONE SURGERY

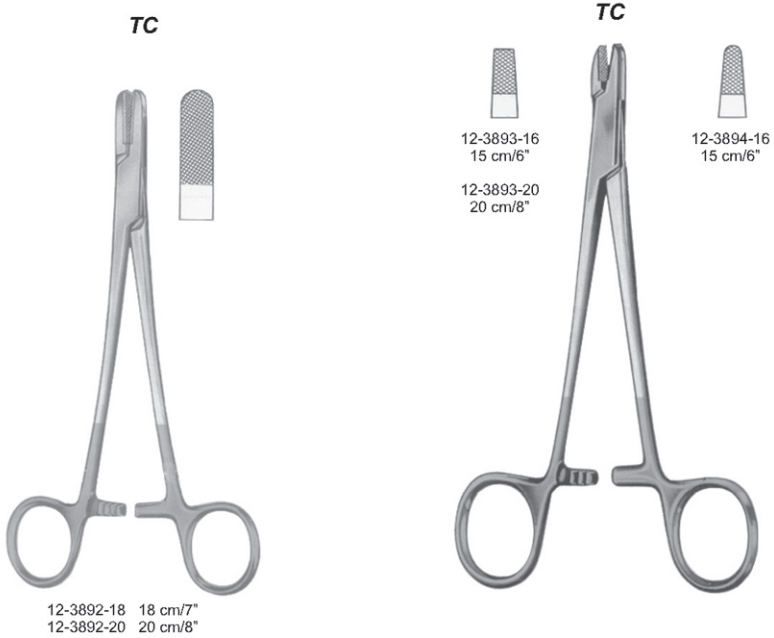
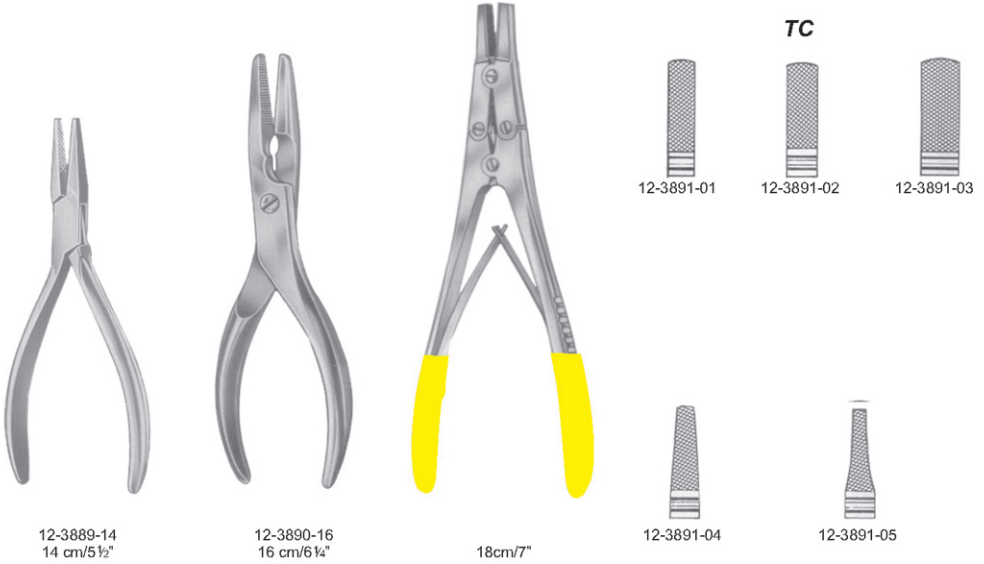

BONE SURGERY



For soft wire  
 with a diam. of max.

12-3895-15  
 15 cm/6"  
 2.0 mm

12-3896-18  
 18.5 cm/7 1/2"  
 1.7 mm

12-3897-16  
 16 cm/6 1/4"  
 2.0 mm

For hard wire  
 with a diam. of max.

1.5 mm

1.7 mm

2.0 mm

## BONE SURGERY

TC



12-3898-12  
0.7 mm  
0.5 mm  
12 cm/4¾"



12-3899-15  
2.0 mm  
1.0 mm  
15 cm/6"



12-3900-18  
2.0 mm  
1.7 mm  
18 cm/7"



212-3901-18  
2.5 mm  
1.5 mm  
18.5 cm/7¼"



12-3902-18  
2.0 mm  
1.7 mm  
18 cm/7"



12-3903-22  
3.0 mm  
2.5 mm  
22 cm/8¾"



12-3904-22  
3.0 mm  
2.2 cm/8¾"

Screw Nut Wrench



12-3905-10  
 10 cm/4"

Screw Driver



12-3906-12  
 12 cm/4 3/4"

Wire Strainer



12-3907-20  
 20 cm/8"

Fixation Discs For Drill Wires



12-3908-30  
 Pair



12-3909-40



12-3910-42

Fixation Discs



12-3911-51  
 Pair

EN	Extension Bows
DE	Extensionsbügel
ES	Estribos para extensión

## BONE SURGERY



With 1 Pin

**Bohler**

cm	in	
h x b	h x b	For Arm
16 x 9	6¼ x 3½	12-3912-16

		For Thigh and Knee
21 x 11	8¼ x 4½	12-3913-21



With 3 Traction Hooks

**Kirschner**

Clear Width	cm	in
12-3914-01	9.5x7	3¾x2¾
12-3914-02	10.5x10.5	4¼x4¼
12-3914-03	12x12	4¾x4¾
12-3914-04	15.5x15.5	6x6
12-3914-05	20x15.5	8x6



Clear Width

12-3915-18	cm	in
12-3915-27	18x10	07x04
	27x16	10½x06¼



With 3 Traction Hooks

**Kirschner**

12-3916-01	Small Pattern
12-3916-02	Medium Pattern
12-3916-03	Large Pattern

**BONE SURGERY**



7 mm Ø



Spare Screw

12-3917-34  
34cm/13½"

**Tendon Passing Instruments**



Malleable

**Bunnell**  
12-3918-18 18cm/7"  
12-3918-23 23cm/9"

**Tendon Strippers**



mm Ø  
4.0 12-3919-40  
4.5 12-3919-45  
5.5 12-3919-55  
Flexible Shaft

**Bunnell**  
23cm/9"



**Fischer**  
12-3920-31  
31 cm/12¼"



**Brand**



12-3921-50  
50 cm/19½"  
06 mm Ø



12-3922-30  
30 cm/12"  
03 mm Ø

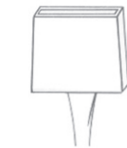

6 x 14 mm

**Brand**  
12-3923-50  
50 cm/19½"

- EN —
- DE —
- ES —

Bone wire, Twisting Instrument and Guides  
 Cerclage-Draht, Drahtumführungsnaedeln  
 Hilo para huesos, Agujas pasa-hilos

**BONE SURGERY**

Bone Wire Guides



Bone Wire Tighteners

**Loute**  
 12-3924-00  
 21 cm/8 1/4"



**Demel**

Bone Wire Guides

- Fig. 1 12-3925-01
- Fig. 2 12-3925-02
- Fig. 3 12-3925-03

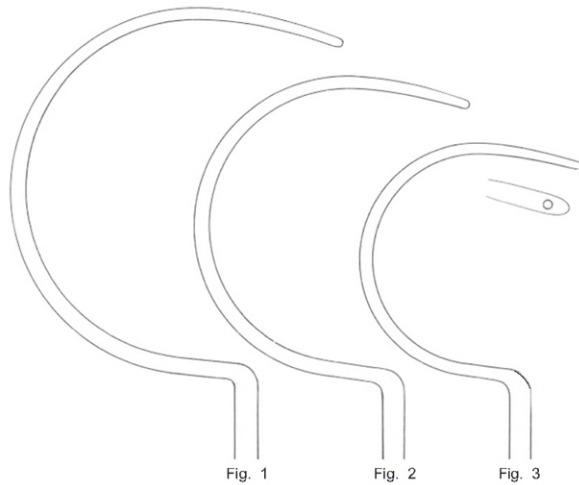
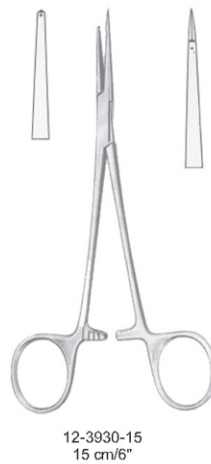
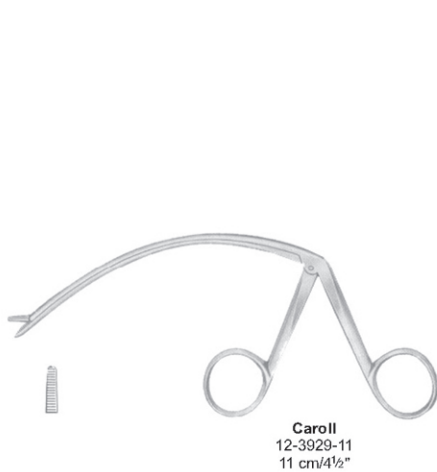
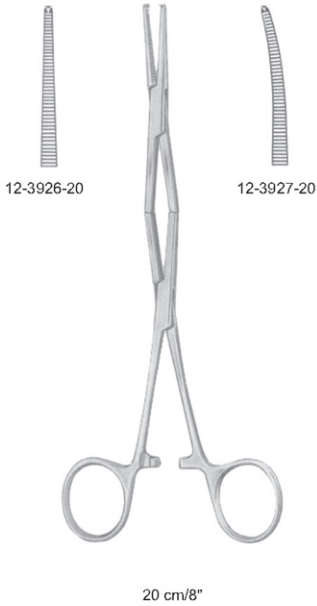

Fig. 1

Fig. 2

Fig. 3

BONE SURGERY





BONE SURGERY



**Steinmann**  
 12-3932-16  
 16 cm/6 1/4"



**Larsen**  
 10 cm/4"



**Kleinert-Kutz**  
 12-3934-20  
 20 cm/8"



**Brand**  
 12-3935-15 15 cm/6"  
 12-3935-19 19 cm/7 1/2"  
 12-3935-24 24 cm/9 1/2"



**Brand**  
 12-3936-15 15 cm/6"  
 12-3936-19 19 cm/7 1/2"  
 12-3936-24 24 cm/9 1/2"