

EN Rhinology

DE Rhinologie

ES Rinología

Page 438 to 462



RHINOLOGY



**Fraenkel**  
18-5001-01 Fig. 1  
18-5001-02 Fig. 2  
18-5001-03 Fig. 3



18-5002-01  
18-5002-02  
18-5002-03  
13 cm/5"



Fig. 1  
18-5003-01  
18-5003-01

Fig. 2  
18-5004-02  
18-5004-02

Fig. 3  
18-5005-03  
18-5005-03



18-5006-01  
18-5006-02  
18-5006-03  
13 cm/5"



**Hartmann**  
15 cm/6"

18-5007-01



Fig. 1

18-5008-01

18-5007-02

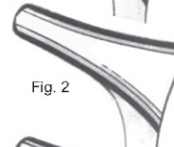

Fig. 2

18-5008-02

18-5007-03

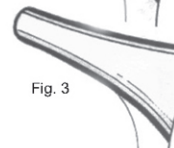

Fig. 3

18-5008-03



**Hartmann**  
15 cm/6"

RHINOLOGY



18-5009-01

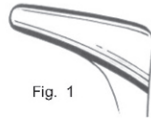

Fig. 1

18-5009-02

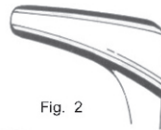

Fig. 2

18-5009-03

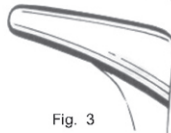

Fig. 3

**Hartmann-Halle**  
15 cm/6"



18-5010-01

18-5010-02

18-5010-03

**Hartmann-Halle**  
15 cm/6"



18-5011-01

18-5011-02



18-5012-01

18-5012-02

**Tieck**  
13.5 cm/5 1/4"



**Tieck**  
13.5 cm/5 1/4"



**Beckmann**  
15 cm/6"

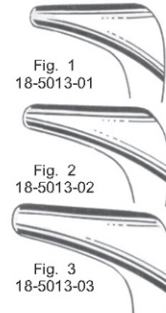

Fig. 1  
18-5013-01

Fig. 2  
18-5013-02

Fig. 3  
18-5013-03

RHINOLOGY



Mod.Wien

18-5014-01



Fig.1

18-5014-02

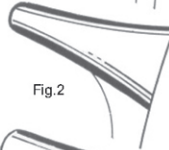

Fig.2

18-5014-03

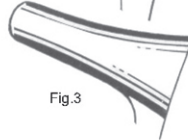

Fig.3

18-5015-01



Wien

18-5015-02

18-5015-03



Killian



Fig.1  
18-5016-01  
35 mm

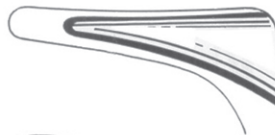

Fig.2  
18-5016-02  
50 mm



Fig.3  
18-5016-03  
75 mm



Fig.4  
18-5016-04  
90 mm



RHINOLOGY



**Cottle**  
 18-5017-01  
 18-5017-02  
 18-5017-03  
 18-5017-04  
 15 cm/6"

**Cottle**  
 18-5018-01  
 18-5018-02  
 18-5018-03  
 18-5018-04  
 15 cm/6"



Fig 1  
 18-5017-01  
 18-5018-01  
 35 mm



Fig 2  
 18-5017-02  
 18-5018-02  
 50 mm



Fig 3  
 18-5017-03  
 18-5018-03  
 75 mm

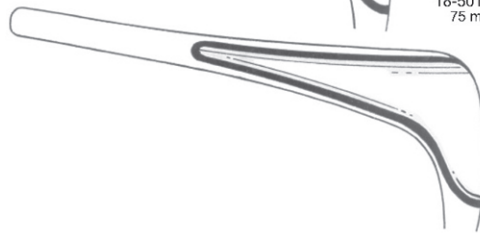

Fig 4  
 18-5017-04  
 18-5018-04  
 90 mm



**Thudicum Nasal Speculum**  
 Length 7 cm

- 18-5019-30 No. 1-3 (set of 3)
- 18-5019-40 No. 1-4 (set of 4)
- 18-5019-70 No. 1-7 (set of 7)



18-5019-01 No. 1    18-5019-02 No. 2    18-5019-03 No. 3    18-5019-04 No. 4



18-5019-05 No. 5    18-5019-06 No. 6    18-5019-07 No. 7

RHINOLOGY



**Krause**  
 18-5020-26  
 26 cm/10<sup>1</sup>/<sub>4</sub>"



**Krause-Voss**  
 18-5021-26  
 26 cm/10<sup>1</sup>/<sub>4</sub>"



**Lange-Wilde**  
 18-5022-24  
 24 cm/9<sup>1</sup>/<sub>2</sub>"



Package Of 1 Dozen Each  
 18-5023-10  
 0.3 mm



Cm	In
15.0	6
18.0	7
20.0	8



Cm	In
15.0	6
18.0	7
20.0	8



**Westmacott (West)**  
 18-5026-20  
 20 cm/8"



**Lubet-Barbon**  
 18-5027-20  
 20 cm/8"

RHINOLOGY



**Hartmann**  
 18-5028-16  
 16 cm/6 1/4"

**Hartmann**  
 18-5029-20  
 20 cm/8"

**Heymann**  
 18-5030-18  
 18 cm/7"

**Craig**  
 18-5031-18  
 18 cm/7"

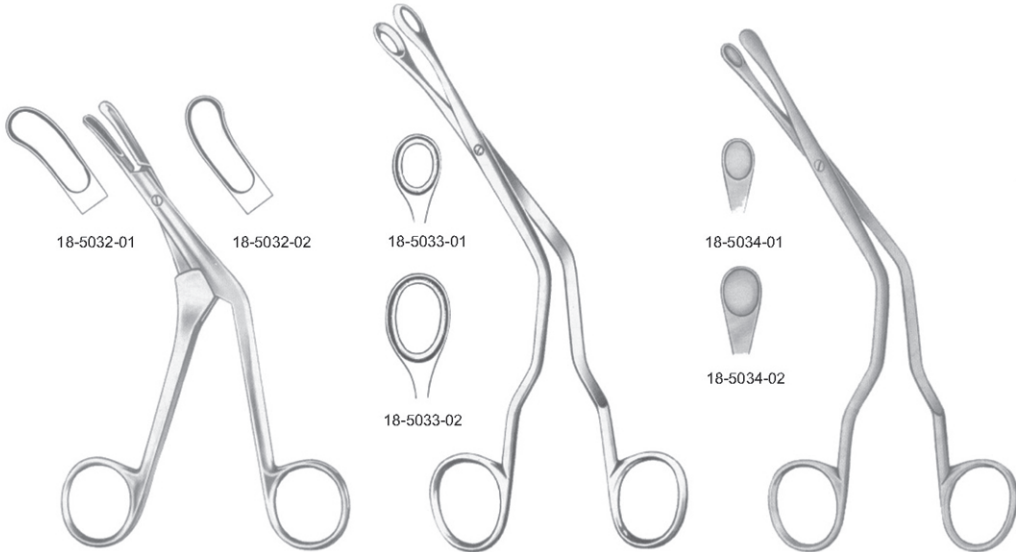

18-5032-01

18-5032-02

18-5033-01

18-5033-02

18-5034-01

18-5034-02

**Craig Domnick**  
 18 cm/7"

**Luc**  
 20 cm/8"

**Luc**  
 20 cm/8"

RHINOLOGY



**Bruenings**  
19 cm/7½"

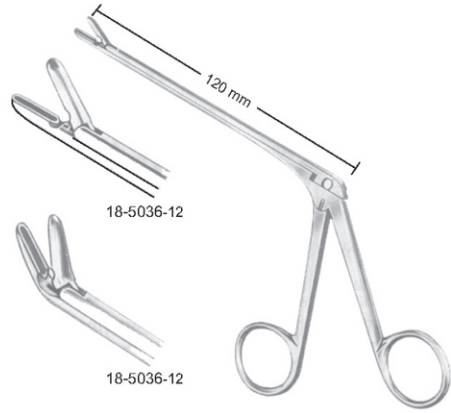

**Takahashi**  
19 cm/7½"



**Watson-Williams**  
19 cm/7½"



**Ferris-Smith**  
18-5038-12  
19 cm/7½"

RHINOLOGY

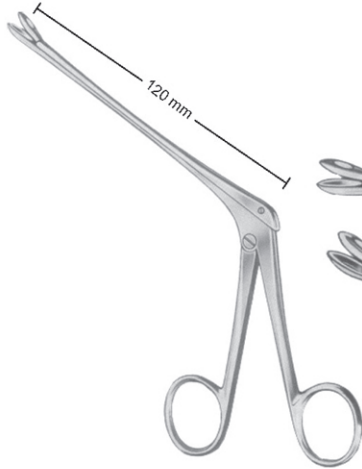

**Weil-Blakesley**

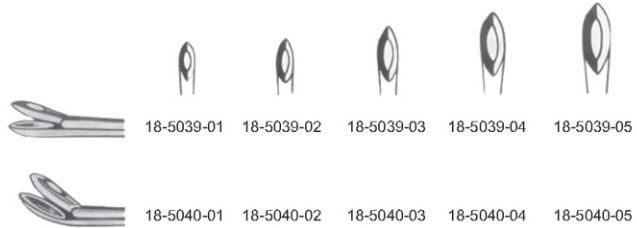

**Struycken**

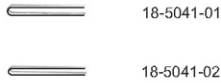

**Hajek**

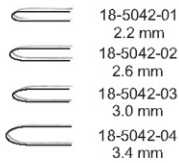

**Myles**



**Grunwald**

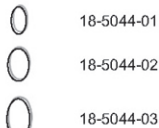

**Hartmann**

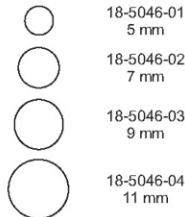

**Schmeden**

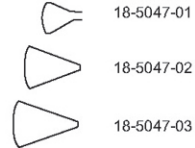

**Grunwald**  
18-5045-01

RHINOLOGY



**Middleton-Jansen**  
18-5048-19  
19 cm/7 1/2"

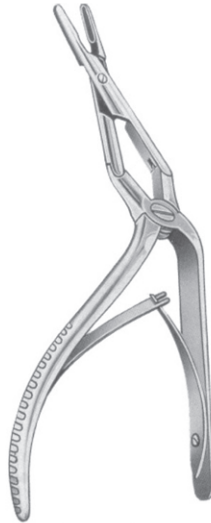

**Middleton-Jansen**  
18-5049-19  
19 cm/7 1/2"



**Kazanjian**  
18-5050-18  
18 cm/7"



**Caplan**  
18-5051-20  
20 cm/8"

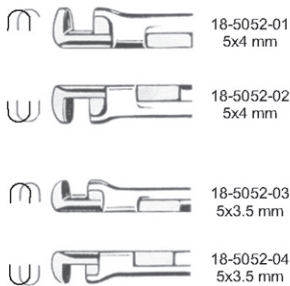

18-5052-01  
5x4 mm

18-5052-02  
5x4 mm

18-5052-03  
5x3.5 mm

18-5052-04  
5x3.5 mm

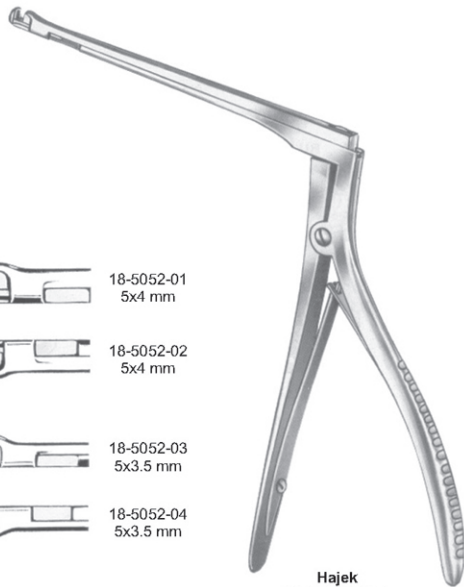

**Hajek  
(Hajek-Kofler)  
Shaft**  
14 cm/5 1/2"

RHINOLOGY



Ferris-Smith-Kerrison



Ferris-Smith-Kerrison

		Width of Bite		Length of Shaft		Width of Bite		Length of Shaft	
		15 cm/6"	20 cm/8"	18 cm/7"	15 cm/6"	20 cm/8"	18 cm/7"	15 cm/6"	20 cm/8"
Cutting Upward		18-5053-03	3 mm	18-5056-03	18-5059-03	1 mm	18-5061-03	18-5064-03	18-5067-01
		18-5053-04	4 mm	18-5056-04	18-5059-04	2 mm			18-5067-02
		18-5053-05	5 mm	18-5056-05	18-5059-05	3 mm			18-5067-03
Cutting Upward 40°		18-5054-03	3 mm	18-5057-03		4 mm	18-5062-03	18-5065-03	18-5068-01
		18-5054-04	4 mm	18-5057-04		5 mm			18-5068-02
		18-5054-05	5 mm	18-5057-05					18-5068-03
		18-5054-06	6 mm	18-5057-06					18-5068-04
Cutting Downward		18-5055-03	3 mm	18-5058-03	18-5060-03	1 mm	18-5063-03	18-5066-03	18-5069-01
		18-5055-04	4 mm	18-5058-04	18-5060-04	2 mm			18-5069-02
		18-5055-05	5 mm	18-5058-05	18-5060-05	3 mm			18-5069-03
		18-5055-06	6 mm	18-5058-06	18-5060-06	4 mm			18-5069-04
						5 mm	18-5063-05	18-5066-05	18-5069-05

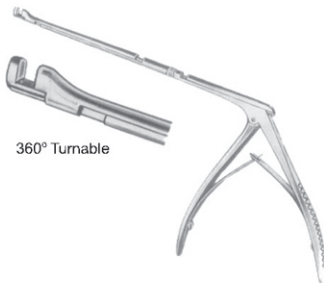

360° Turnable

Hajek-Kofler  
 18-5070-16  
 16 cm/6½"

- 18-5071-03  
3 mm
- 18-5071-04  
4 mm
- 18-5071-05  
5 mm
- 18-5071-06  
6 mm



Kerrison  
 20 cm/8"

**RHINOLOGY**



**Jurasz**  
22 cm/8¾"



18-5072-01



18-5072-02



18-5072-03

**Rhinoplastic and Nasal Knives**



**Joseph**  
Pointed

← Straight  
18-5073-01



Curved  
18-5074-01



**Joseph**  
Blunt

← Straight  
18-5075-01



Curved  
18-5076-01



**Converse**  
18-5077-15  
15 cm/6"



**Joseph**  
18-5078-14  
14 cm/5½"



- EN —●—
- DE —●—
- ES —●—

Rhinoplastic, Nasal and Septum Knives  
 Nasenplastik- und operationsmesser  
 Bisturías para plástica y operaciones de l nariz

RHINOLOGY



**Cottle**  
 18-5079-15  
 15 cm/6"



**Cottle**  
 18-5080-14  
 14 cm/5½"



**Freer**  
 18-5081-16  
 16 cm/6¼"



**Joseph**  
 18-5082-16  
 16.5 cm/6½"



**Maltz**  
 18-5083-16  
 16.5 cm/6½"



**Freer**  
 18-5084-19  
 19 cm/7½"

Septum Knives



**Ballenger**  
 20cm/8"



18-5085-03 3 mm 18-5086-03  
 18-5085-04 4 mm 18-5086-04  
 18-5085-05 5 mm 18-5086-05



**Ballenger**  
 20cm/8"



**Bruenings**  
 18-5087-16

RHINOLOGY



18-5088-04 4 mm  
18-5088-05 5 mm

**Mc Kenty**  
15 cm/6"



**Halle**  
18-5089-16  
16.5 cm/6½"



**Joseph**  
18-5090-16  
16.5 cm/6½"



**Cottle**  
18-5091-19  
19.5 cm/7½"



Blunt

**Freer**  
18-5092-19  
19 cm/7½"



Sharp

**Freer**  
18-5093-19  
19 cm/7½"



**Freer**  
18-5094-18  
18 cm/7"

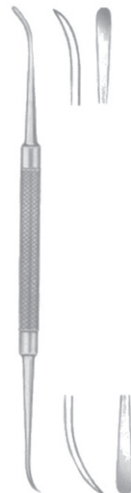

**Freer-Yasargil**  
18-5095-18  
18.5 cm/7¼"



**Howarth**  
18-5096-21  
21.5 cm/8½"



**Mc Kenty**  
18-5097-22  
22 cm/8¾"



- EN — Nasal Septum Elevators
- DE — Septum-Elevatorien
- ES — Elevadores y Espátulas para el tabique nasal

Nasal Septum Elevators  
 Septum-Elevatorien  
 Elevadores y Espátulas para el tabique nasal

RHINOLOGY

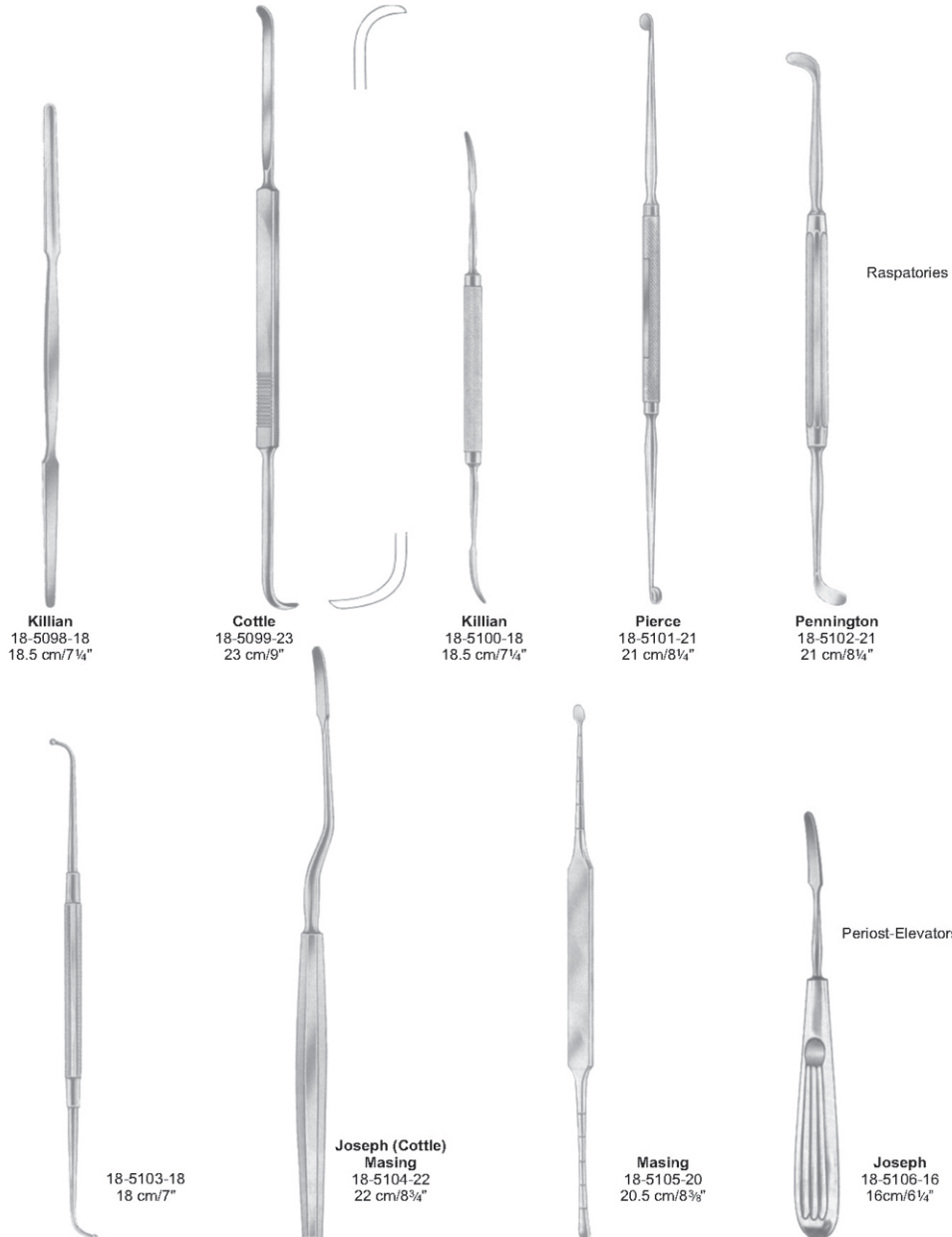

Raspatories

Periost-Elevators

**Killian**  
 18-5098-18  
 18.5 cm/7¼"

**Cottle**  
 18-5099-23  
 23 cm/9"

**Killian**  
 18-5100-18  
 18.5 cm/7¼"

**Pierce**  
 18-5101-21  
 21 cm/8¼"

**Pennington**  
 18-5102-21  
 21 cm/8¼"

18-5103-18  
 18 cm/7"

**Joseph (Cottle)  
 Masing**  
 18-5104-22  
 22 cm/8¾"

**Masing**  
 18-5105-20  
 20.5 cm/8⅝"

**Joseph**  
 18-5106-16  
 16cm/6¼"

**RHINOLOGY**



**Freer**  
 18-5107-16  
 16 cm/6¼"



**Freer**  
 18-5108-16  
 16 cm/6¼"



**Freer**  
 18-5109-15  
 15 cm/6"



**Ballenger**  
 18-5110-04 4 mm  
 18-5110-06 6 mm  
 18-5110-08 8 mm  
 16 cm/6¼"



**Killian**  
 18-5111-16  
 16 cm/6¼"



**Killian-Claus**  
 18-5112-16  
 16 cm/6¼"

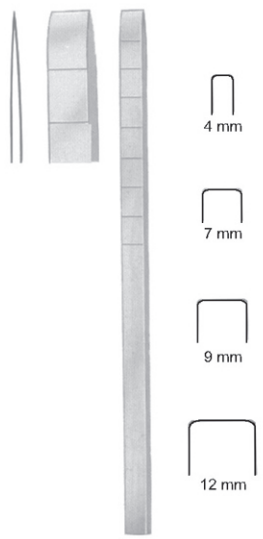

**Cottle**  
 18-5113-04 4 mm  
 18-5113-07 7 mm  
 18-5113-09 9 mm  
 18-5113-12 12 mm  
 18 cm/7"



**Cottle**  
 18-5114-04 4 mm  
 18-5114-07 7 mm  
 18-5114-09 9 mm  
 18-5114-12 12 mm  
 18 cm/7"



**Cottle**  
 18-5115-18  
 18 cm/7"



**Cottle**  
 18-5116-18  
 18 cm/7"

RHINOLOGY



18-5117-08  
 16 cm/6¼"  
 8 mm



**Cottle**  
 18-5118-04 4 mm  
 18-5118-07 7 mm  
 18-5118-09 9 mm  
 18-5118-12 12 mm  
 18 cm/7"



**Cottle Curved**  
 18-5119-06  
 18 cm/7"  
 6 mm



**Fomon**  
 18-5120-05 5mm  
 18-5120-08 8mm  
 17 cm/6¾"



**Walter**  
 18-5121-03 3 mm  
 18-5121-04 4 mm  
 18 cm/7"



18-5122-01



**(Silver) Masing**  
 18-5123-02  
 17.5 cm/7½"



18-5124-03

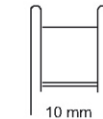

10 mm

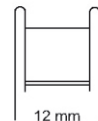

12 mm



14 mm

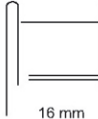

16 mm

**Cinelli**  
 18-5125-10 10 mm  
 18-5125-12 12 mm  
 18-5125-14 14 mm  
 18-5125-16 16 mm  
 16 cm/6¼"



**Masing**  
 18-5126-17  
 17.5 cm/6⅞"



**West**  
18-5127-16  
16 cm/6¼"



**West**  
18-5128-16  
16 cm/6¼"



18-5129-01

18-5129-02

**Joseph**  
17 cm/6¾"



**Joseph**  
18-5130-01  
17 cm/6¾"



**Joseph**  
18-5131-02  
17 cm/6¾"



**Joseph**  
18-5132-03  
17 cm/6¾"

RHINOLOGY

TC



Fig.1



Fig.3



Fig.5



Fig.7



Fig.9



Fig.2



Fig.4



Fig.6



Fig.8



Fig.10

**Famon**

- Fig. 1/2 18-5133-12
  - Fig. 3/4 18-5133-34
  - Fig. 5/6 18-5133-56
  - Fig. 7/8 18-5133-78
  - Fig. 9/10 18-5133-90
- 21 cm/8 1/4"

TC



**Parkes**

- Fig. 1 18-5134-01
  - Fig. 2 18-5134-02
  - Fig. 3 18-5134-03
  - Fig. 4 18-5134-04
  - Fig. 5 18-5134-05
  - Fig. 6 18-5134-06
  - Fig. 7 18-5134-07
  - Fig. 8 18-5134-08
  - Fig. 9 18-5134-09
  - Fig.10 18-5134-10
- 20.5 cm/8 1/8"

**Maltz**

- Fig. 1 18-5135-01
  - Fig. 2 18-5135-02
  - Fig. 3 18-5135-03
  - Fig. 4 18-5135-04
  - Fig. 5 18-5135-05
  - Fig. 6 18-5135-06
  - Fig. 7 18-5135-07
  - Fig. 8 18-5135-08
  - Fig. 9 18-5135-09
  - Fig.10 18-5135-10
- 17 cm/6 1/2"

RHINOLOGY



**Maltz**  
18-5141-18  
18 cm/7"



**Joseph**  
16 cm/6 1/4"



18-5142-01



18-5142-02



**Lewis**  
18 cm/7"



**Fine**  
18-5143-01



**Coarse**  
18-5143-02



**Cottle**  
18-5144-21  
21 cm/8 1/4"



**Aufricht**  
21 cm/8 1/4"

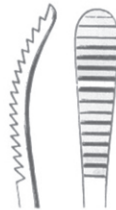

18-5145-01

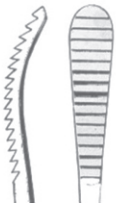

18-5145-02



RHINOLOGY



**Maltz**  
17 cm/6¾"



18-5136-01



18-5136-02



**Miller**  
16 cm/6¼"



18-5137-01



18-5137-02

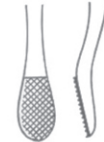

19 cm/7½"



18-5138-02



18-5138-03



18-5138-04



18-5138-05



18-5138-06



18-5138-07



**Aufricht**  
18-5139-17  
17.5 cm/6¾"



**Fomon**  
18-5140-21  
21 cm/8¼"



**RHINOLOGY**

**Hooks**



**Fomon**  
18-5146-14  
14.5 cm/5 3/4"



**Cottle**  
18-5147-14  
14.5 cm/5 3/4"



**Cottle**  
18-5148-14  
14.5 cm/5 3/4"



**Cottle**  
18-5149-14  
14.5 cm/5 3/4"



**Cottle**  
18-5150-16  
15 cm/6"



**Kilner**  
18-5151-08  
8 cm/3 1/8"  
10 mm

**Columella Forceps**



**Converse**  
18-5152-12  
12 cm/4 3/4"

**Aufricht**  
18-5153-16  
16 cm/6 1/4"



**Cottle**  
18-5154-10  
10 cm/4"

**Tissue Lifter**



18-5155-14  
14 cm/5 1/2"

**Tissue Picks**



18-5156-11  
11 cm/4 3/8"



1.0 mm 18-5157-10  
1.8 mm 18-515718

RHINOLOGY



**Walsham**  
23 cm/9"



18-5158-01



18-5158-02



18-5158-03



**Cottle-Walsham**  
18-5159-22  
22 cm/8¾"



**Asch**  
18-5160-23  
23 cm/9"



**Kressner**  
18-5161-20  
20 cm/8"



**Rubin**  
18-5162-20  
20 cm/8"

**RHINOLOGY**



**Faulkner**  
18-5163-21  
21 cm/8¼"



**Sewall**  
18-5164-20  
20 cm/8" 6 mm



**Coakley**  
17 cm/6½"



18-5165-01



18-5165-02



18-5165-03



18-5165-04



18-5165-05



18-5165-06

Ringmesser



**Beckmann**  
22 cm/8¾"

18-5166-01



18-5167-01

18-5166-02



18-5167-02

18-5166-03



18-5167-03

18-5166-04



18-5167-04

18-5166-05



18-5167-05

18-5166-06



18-5167-06

Adenoid Currettes



**Negus**  
20 cm/8"

RHINOLOGY

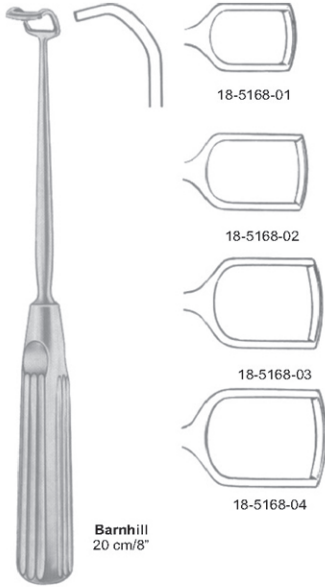

**Barnhill**  
20 cm/8"

18-5168-01

18-5168-02

18-5168-03

18-5168-04

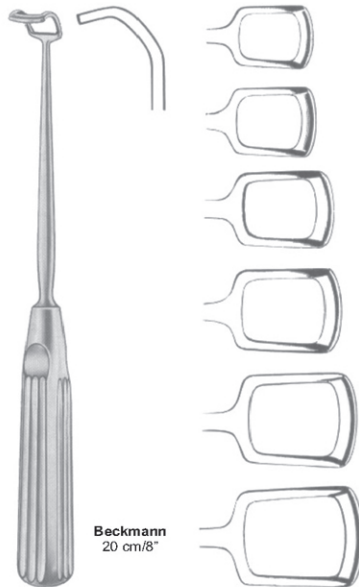

**Beckmann**  
20 cm/8"

18-5169-01

18-5169-02

18-5169-03

18-5169-04

18-5169-05

18-5169-06

18-5170-10 10mm  
 18-5170-12 12mm  
 18-5170-14 14mm  
 18-5170-16 16mm  
 18-5170-18 18mm

18-5170-10A 10mm  
 18-5170-12A 12mm  
 18-5170-14A 14mm  
 18-5170-16A 16mm  
 18-5170-18A 18mm



**St. Clair-Thompson**  
with graded  
21.5cm/8 1/2"



**St. Clair-Thompson**  
without graded  
21.5cm/8 1/2"



**La Force**  
23 cm/9"



18-5171-01



18-5171-02



18-5171-03

Spare blades Only

18-5171-11

18-5171-12

18-5171-13

RHINOLOGY



**Bruenings- Brunk**  
 18-5172-19  
 91 cm/7 1/2"

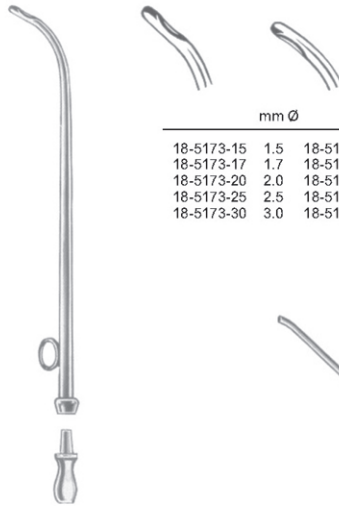

**Siebenmann**

mm Ø		
18-5173-15	1.5	18-5174-15
18-5173-17	1.7	18-5174-17
18-5173-20	2.0	18-5174-20
18-5173-25	2.5	18-5174-25
18-5173-30	3.0	18-5174-30



**Hartmann**  
 Fig. 1 mm Ø Fig. 2

18-5175-20	18-5176-20
18-5175-25	18-5176-25
18-5175-30	18-5176-30



**Eicken - Killian**  
 18-5177-03  
 3 mm Ø



**Killian**  
 18-5178-15  
 1.5 mm Ø



**Ritter - Halle**  
 2.5 mm 18-5179-25  
 3.0 mm 18-5179-30  
 4.0 mm 18-5179-40