

- EN** Stomach, Intestine, Rectum
- DE** Magen, Darm, Mastdarm
- ES** Estómago, Intestinos, Recto

Page 483 to 504

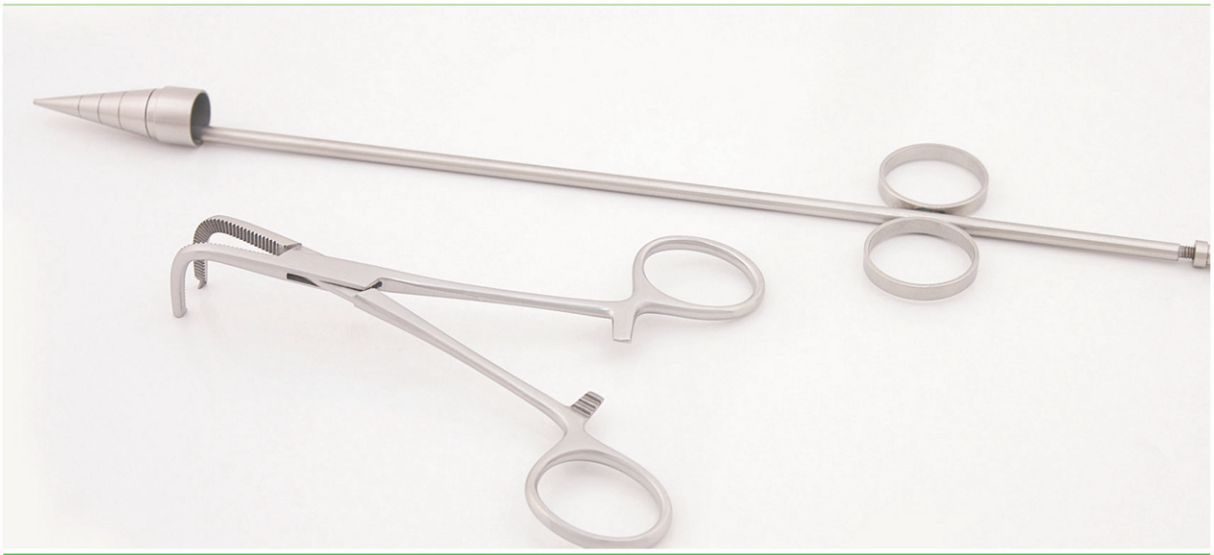

STOMACH, INTESTINE & RECTUM



**Allis**

cm	in	4 : 5	5 : 6
15	6"	24-5801-15	24-5802-15
19	7½"	24-5802-19	24-5802-19
23	9"	24-5802-23	24-5802-23
25	10"	24-5802-25	24-5802-25



**Baby-Allis**

24-5803-12	12 cm/4¾"
24-5803-14	14 cm/5½"

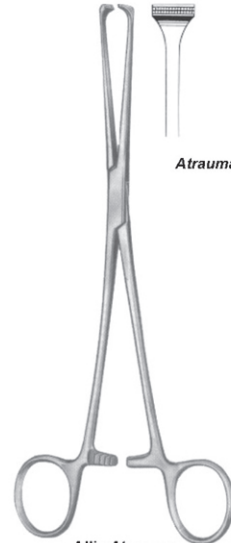

**Atrauma**

**Allis-Atrauma**

24-5804-16	16 cm/6¼"
24-5804-20	20 cm/8"
24-5804-25	25 cm/10"
24-5804-30	30 cm/12"



**Allis-Adair**

24-5805-15	15 cm/6"
------------	----------



**Baby-Allis**

24-5806-15	15 cm/6"
------------	----------



**Lockwood-Allis**

24-5807-16	16 cm/6¼"
24-5807-20	20 cm/8"



**Thoms-Allis**

24-5808-20	20 cm/8"
------------	----------

- EN — Tissue Seizing and Intestinal Atrauma Tissue Forceps
- DE — Tissue Beschlagnahme und Darm Atrauma Tissue Zange
- ES — Aprovechando el tejido intestinal y pinzas de tejido Atrauma

**STOMACH, INTESTINE & RECTUM**

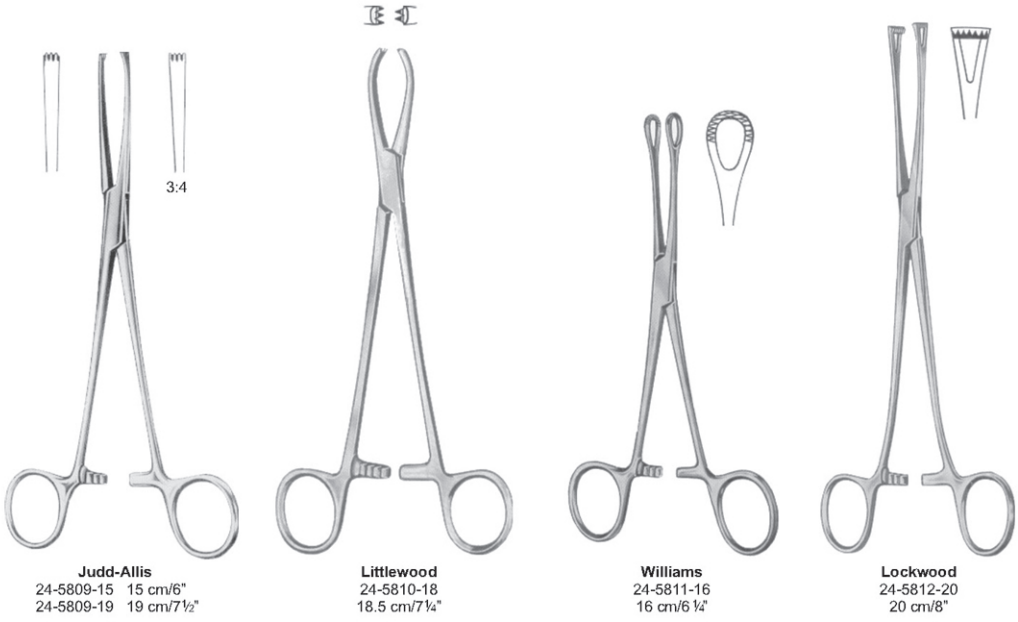

**Judd-Allis**  
24-5809-15 15 cm/6"  
24-5809-19 19 cm/7½"

**Littlewood**  
24-5810-18  
18.5 cm/7½"

**Williams**  
24-5811-16  
16 cm/6 ¼"

**Lockwood**  
24-5812-20  
20 cm/8"

**Atrauma**



cm/in	Babcock-Atrauma	Babcock(Standard)	Baby-Babcock	Babcock
16 cm/6½"	24-5813-16	24-5814-16	24-5815-16	24-5816-16
18 cm/7"		24-5814-18		
20 cm/8"	24-5813-20	24-5814-20		24-5816-20
24 cm/9½"		24-5814-24		

STOMACH, INTESTINE & RECTUM

**Atrauma**

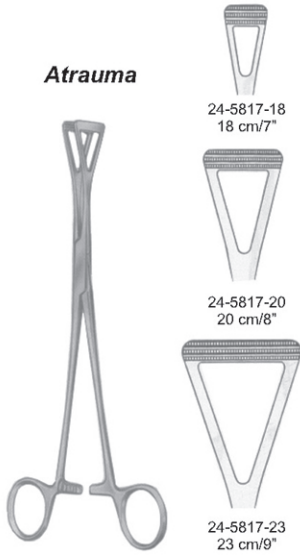

	Duval		
	cm	in	
24-5818-18	18	7"	
24-5818-20	20	8"	24-5819-20
24-5818-23	23	9"	24-5819-23

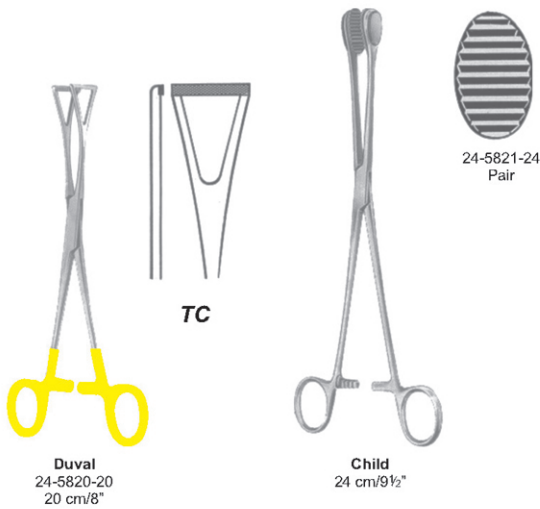

**Atrauma**

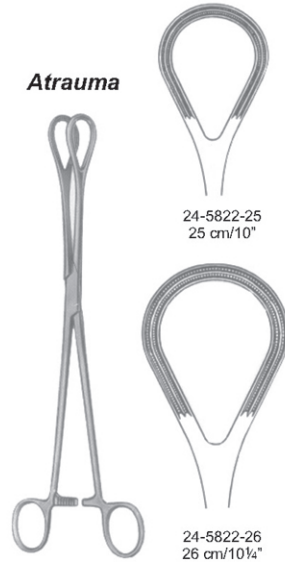



STOMACH, INTESTINE & RECTUM



**Baby-Doyen**  
 Straight 24-5823-18 18 cm/7"  
 Curved 24-5824-18 18 cm/7"

**Doyen**  
 Straight 24-5825-21 21 cm/8 ¼  
 24-5825-23 23 cm/9"  
 Curved 24-5826-21 21 cm/8 ¼  
 24-5826-23 23 cm/9"

**Scudder**  
 24-5827-25 25 cm/10"

**STOMACH, INTESTINE & RECTUM**



**Doyen-Atrauma**

**Atrauma**

Straight



24-5828-13  
13 cm/5"



24-5828-16  
16 cm/6¼"



24-5828-18  
18 cm/7"



24-5828-21  
21 cm/8¼"



24-5828-23  
23 cm/9"

**Atrauma**

Curved



24-5829-13  
13 cm/5"



24-5829-16  
16 cm/6¼"



24-5829-18  
18 cm/7"



24-5829-21  
21 cm/8¼"



24-5829-23  
23 cm/9"

STOMACH, INTESTINE & RECTUM



Mayo-Robson  
 Mayo-Robson Atrauma

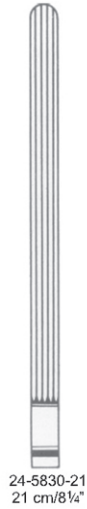

24-5830-21  
 21 cm/8¼"



24-5831-21  
 21 cm/8¼"

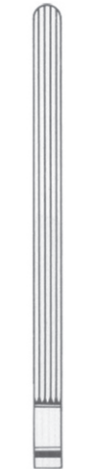

24-5832-23  
 23 cm/9"



24-5833-23  
 23 cm/9"

**Atrauma**

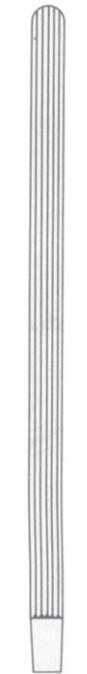

24-5834-25  
 25 cm/10"



24-5835-25  
 25 cm/10"

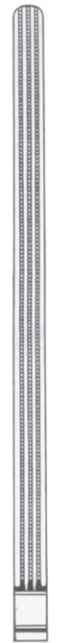

24-5836-25  
 25 cm/10"

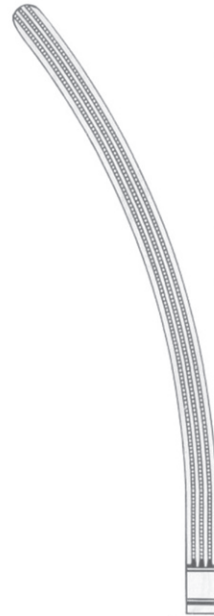

24-5837-25  
 25 cm/10"

**STOMACH, INTESTINE & RECTUM**



**Resano**  
24-5838-30  
30 cm/12"



**Hayes**



24-5839-26  
26 cm/10 1/4"

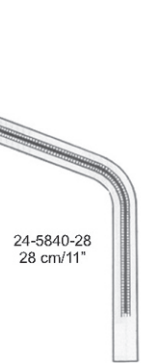

24-5840-28  
28 cm/11"

**Atrauma**



**Fehland**  
24-5841-24  
24 cm/9 1/2"



**Brunner**  
24 cm/9 1/2"



24-5842-24



24-5843-24

**Atrauma**

STOMACH, INTESTINE & RECTUM



**Baby-Kocher**  
 Straight 24-5844-13 13 cm/5"  
 Curved 24-5845-13 13 cm/5"



**Kocher**



24-5846-22  
 22 cm/8 3/4"



24-5846-25  
 25 cm/10"



24-5846-28  
 28 cm/11"



24-5847-22  
 22 cm/8 3/4"



24-5847-25  
 25 cm/10"



24-5847-28  
 28 cm/11"

**Atrauma**



**Kocher-Atrauma**



24-5848-22  
22 cm/8 3/4"



24-5848-25  
25 cm/10"



24-5848-28  
28 cm/11"



24-5849-22  
22 cm/8 3/4"



24-5849-25  
25 cm/10"



24-5849-28  
28 cm/11"

STOMACH, INTESTINE & RECTUM

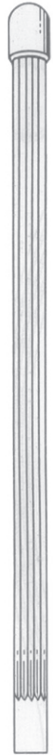

**Straight**  
24-5851-25



**Nussbaum**  
25 cm/10"



**Curved**  
24-5852-25



**Benson**  
24-5850-15  
15.5 cm/6"

Pylorus spreader



**Allen**  
24-5853-15 15.5 cm/6"  
24-5853-20 20.0 cm/8"



**Kleinschmidt**  
24-5854-12  
12 cm/4¾"

Blindgut forceps

**STOMACH, INTESTINE & RECTUM**



**Payr**  
**(Payr-Baby)**

For children



24-5855-15  
15 cm/6"



24-5856-21  
21 cm/8 1/4"

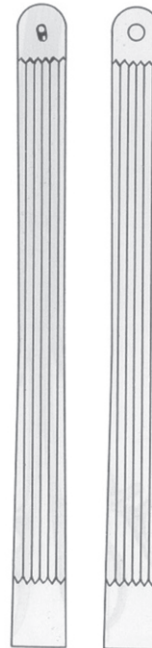

24-5857-29  
29 cm/11 1/2"

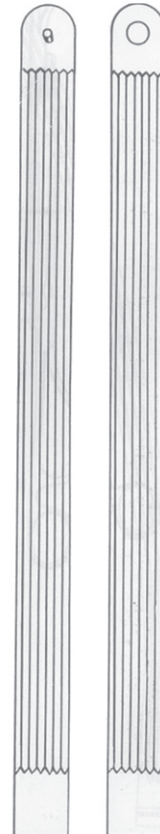

24-5858-35  
35 cm/13 3/4"



STOMACH, INTESTINE & RECTUM

Twin Clamps Forceps



**Lane**  
30 cm/12"



**Straight**  
24-5859-30

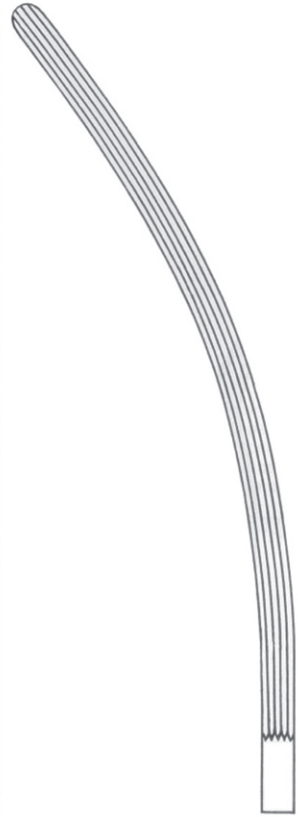

**Curved**  
24-5860-30

STOMACH, INTESTINE & RECTUM

**Atrauma**



**Scudder  
Scudder-Atrauma**  
33 cm/13"



**Straight**  
24-5861-33



**Curved**  
24-5862-33



**Straight**  
24-5863-33

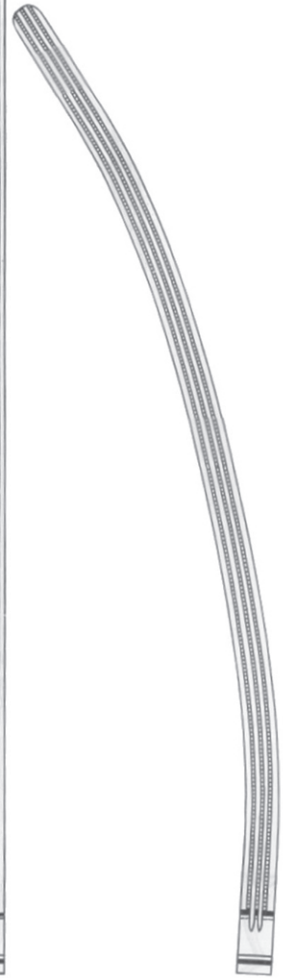

**Curved**  
24-5864-33

STOMACH, INTESTINE & RECTUM

Intestinal and Stomach Twin Clamps

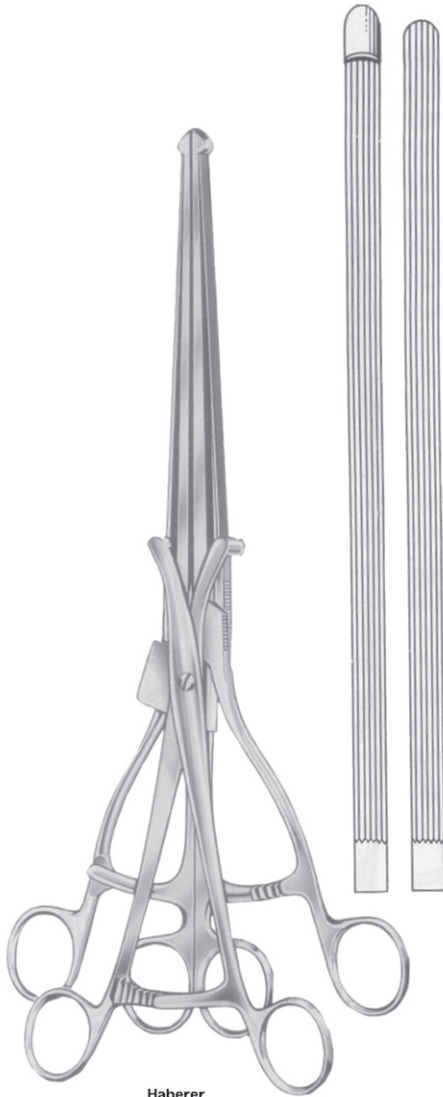

**Haberer**  
 24-5865-36  
 36 cm/14"



**Straigh**  
 24-5866-30

**Nussbaum**  
 30 cm/12"

**Curved**  
 24-5867-30

STOMACH, INTESTINE & RECTUM



**Czerny**  
24-5868-22  
22 cm/8¾"



**Pratt**  
24-5869-20  
80 x 25 mm  
20.5 cm/8"



**Sims**  
25-08291-15

**(Bodenhammer) Sims**  
24-5870-15  
15 cm/6"

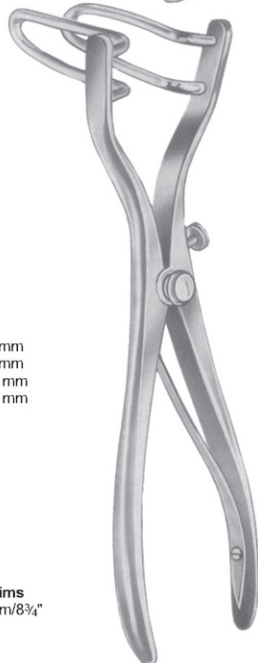

**Sims**  
22 cm/8¾"

Length of Blades  
24-5871-06  
24-5871-08  
24-5871-12  
24-5871-15

60 mm  
80 mm  
125 mm  
150 mm



**Mathieu**  
24-5872-19  
90 x 15 mm  
19.5 cm/7¾"

STOMACH, INTESTINE & RECTUM



**Barr**  
 24-5873-17  
 17 cm/6¾"  
 70 X 22 mm

Anal Retractors

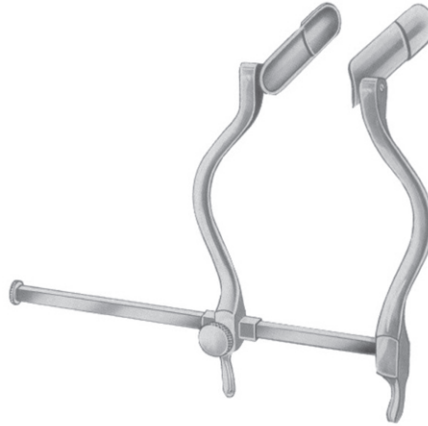

**Smith-Bule**  
 24-5874-15  
 15 cm/6"

Anoscopes



**Hirschmann**  
 24-5875-01  
 24-5875-02  
 24-5875-03  
 24-5875-04

Fig. 1 16 mm Ø x 65 mm  
 Fig. 2 19 mm Ø x 65 mm  
 Fig. 3 22 mm Ø x 65 mm  
 Fig. 4 25 mm Ø x 65 mm



**Bensaude**  
 24-5876-01  
 24-5876-02

Fig. 1 19 mm Ø x 70 mm  
 Fig. 2 22 mm Ø x 70 mm

STOMACH, INTESTINE & RECTUM

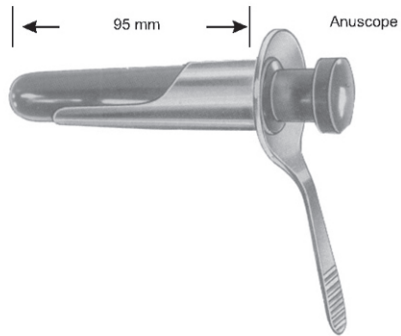

**Ives-Fansler**  
24-5877-22  
22 mm Ø

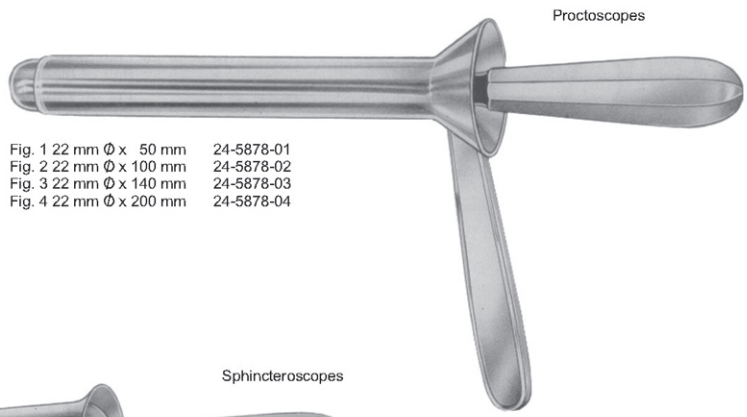
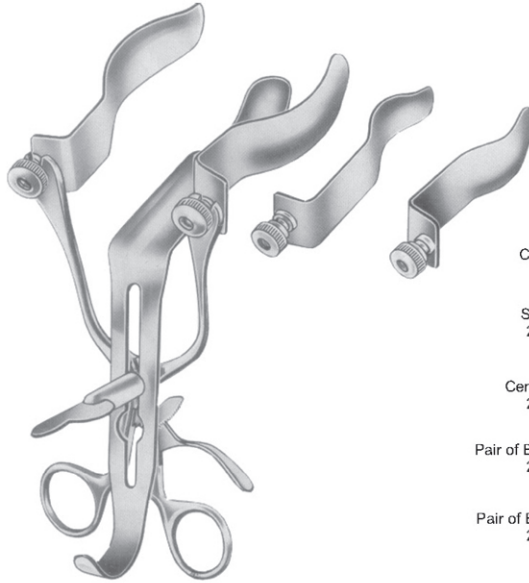

Fig. 1 22 mm Ø x 50 mm 24-5878-01  
Fig. 2 22 mm Ø x 100 mm 24-5878-02  
Fig. 3 22 mm Ø x 140 mm 24-5878-03  
Fig. 4 22 mm Ø x 200 mm 24-5878-04



**Kelly**  
Fig. 1 21 mm Ø 50 mm 24-5879-01  
Fig. 2 27 mm Ø 50 mm 24-5879-02

STOMACH, INTESTINE & RECTUM



**Park**  
 24-5880-00  
 14.5 cm/5¾"

Consisting of:

Spreader only  
 24-5880-01

Center Blade only  
 24-5880-02

Pair of Blades Only 75 mm  
 24-5880-03

Pair of Blades only 95 mm  
 24-5880-04



**Park**  
 24-5881-00  
 13 cm/5"

Consisting of:

Spreader only  
 24-5881-01

Pair of Blades only 95 mm  
 24-5881-02

STOMACH, INTESTINE & RECTUM

Length of Shaft

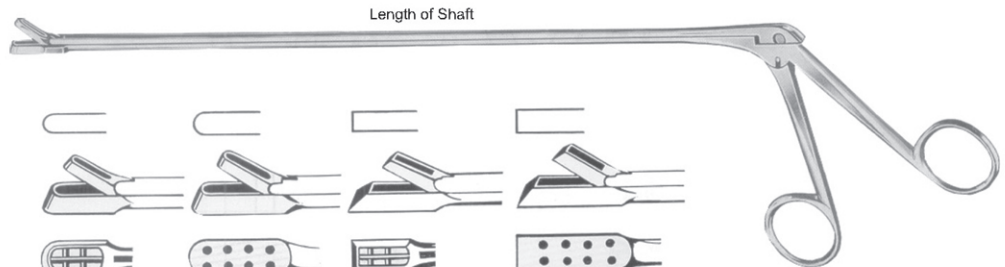



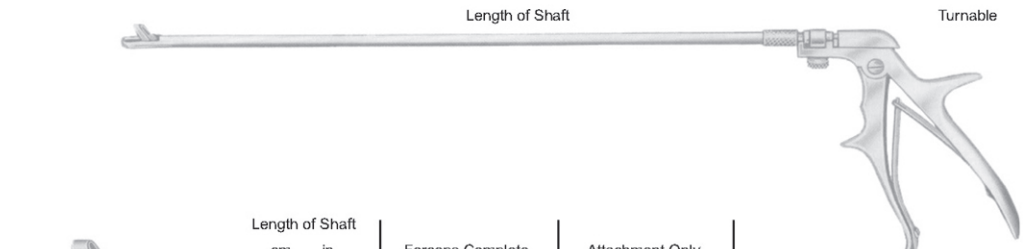

		cm	in	
1	2	28	11	<b>Yeoman</b>
24-5882-28	24-5883-28	35	13 <sup>3</sup> / <sub>4</sub> "	
24-5882-35	24-5883-35	42	16 <sup>1</sup> / <sub>2</sub> "	
24-5882-42	24-5883-42			
3	4			
24-5884-28	24-5885-28			
24-5884-35	24-5885-35			
24-5884-42	24-5885-42			

Length of Shaft

Turnable



	Length of Shaft		Forceps Complete	Attachment Only
	cm	in		
	33	13	24-5886-33 24-5886-40	24-5890-33 24-5890-40
	40	16		
	33	13	24-5887-33 24-5887-40	24-5891-33 24-5891-40
	40	16		
	33	13	24-5888-33 24-5888-40	24-5892-33 24-5892-40
	40	16		
	33	13	24-5889-33 24-5889-40	24-5893-33 24-5893-40
	40	16		

**Yeoman (Turrell)**  
 Handle Only  
 24-5894-00



STOMACH, INTESTINE & RECTUM

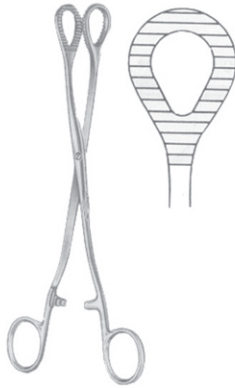

**Heywood-Smith**  
 24-5895-21  
 21 cm/8¼"



**Heywood-Smith**  
 24-5896-21  
 21 cm/8¼"

Rectal Snare



**Norwood**  
 24-5897-30  
 30 cm/12"

Rectal Aspiration Cannula



**Buie**  
 24-5898-40  
 Charr. 10. 40 cm/15¾"

Rectal Coolers



24-5899-01



24-5900-02

STOMACH, INTESTINE & RECTUM

Aspiration Tip

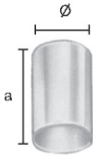

	a	ø
24-5901-11	11 mm	10 mm
24-5901-16	16 mm	10 mm

Charging Cone



10 mm ø

24-5902-10

Charging Cone



12 mm ø

24-5903-12

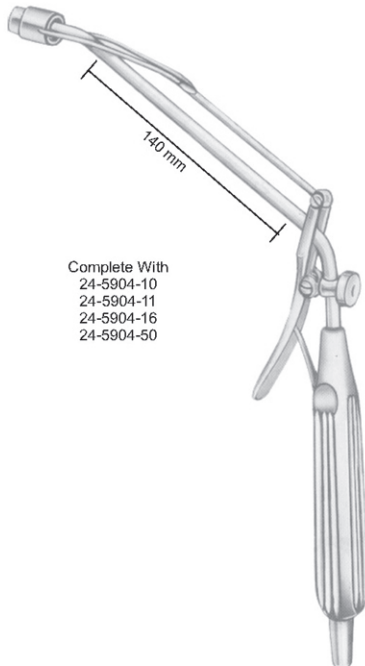

Complete With  
 24-5904-10  
 24-5904-11  
 24-5904-16  
 24-5904-50

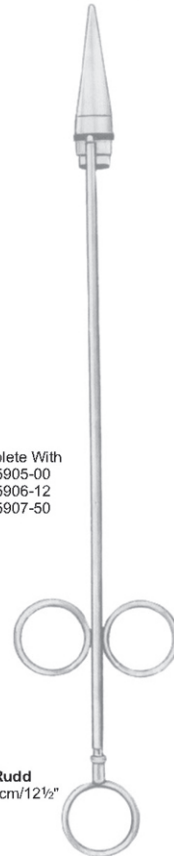

Complete With  
 24-5905-00  
 24-5906-12  
 24-5907-50

**Rudd**  
 31.5 cm/12½"

STOMACH, INTESTINE & RECTUM

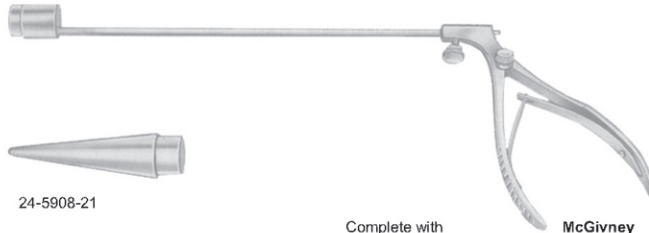

24-5908-21

Complete with  
24-5908-00

**McGivney**  
24-5908-01



Complete with  
24-5909-00

**Ford Dixon**  
24-5909-01

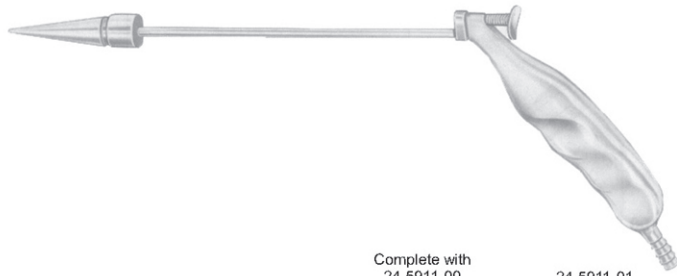

Complete with  
24-5911-00

24-5911-01



**McGivney**  
24-5910-19  
19 cm/7 1/2"



24-5912-00  
Ligator rubber rings  
in box of 100 pieces