

EN Kidney, Liver, Gall Stone, Urology

DE Niere, Leber, Galle, Urologie

ES Riñón, Hígado, Bilis, Urología

Page 505 to 518





Guyon

25-6001-20
20 cm/8"



25-6001-22
22 cm/8¾"



25-6001-24
24 cm/9½"

Atrauma



25-6002-23
23 cm/9"



25-6002-24
24 cm/9½"

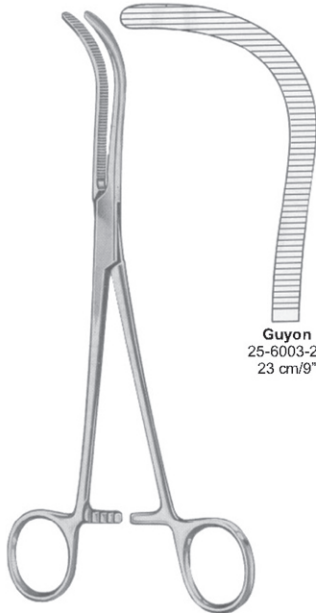

Guyon
25-6003-23
23 cm/9"

- EN — Kidney Pedicle Clamp Forceps
 DE — Kidney Gestielte Klammerzange
 ES — Pinzas de riñón Clamp pediculares

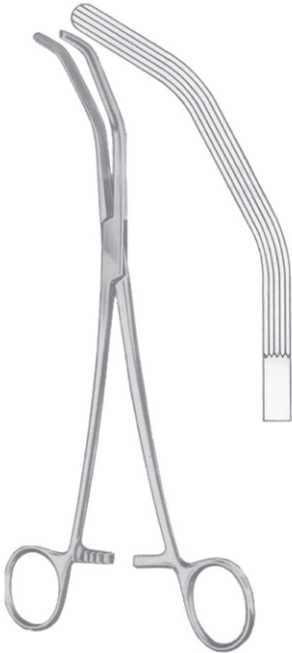
KIDNEY, UROLOGY INSTRUMENTS

Herrick
 25-6004-23
 23 cm/9"

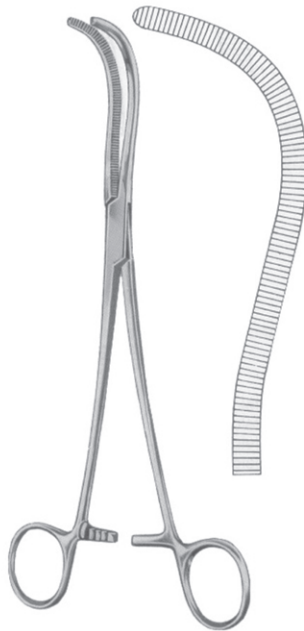

Mayo-Guyon
 25-6005-23
 23 cm/9"



Stille
 25-6006-23
 23 cm/9"

KIDNEY, UROLOGY INSTRUMENTS

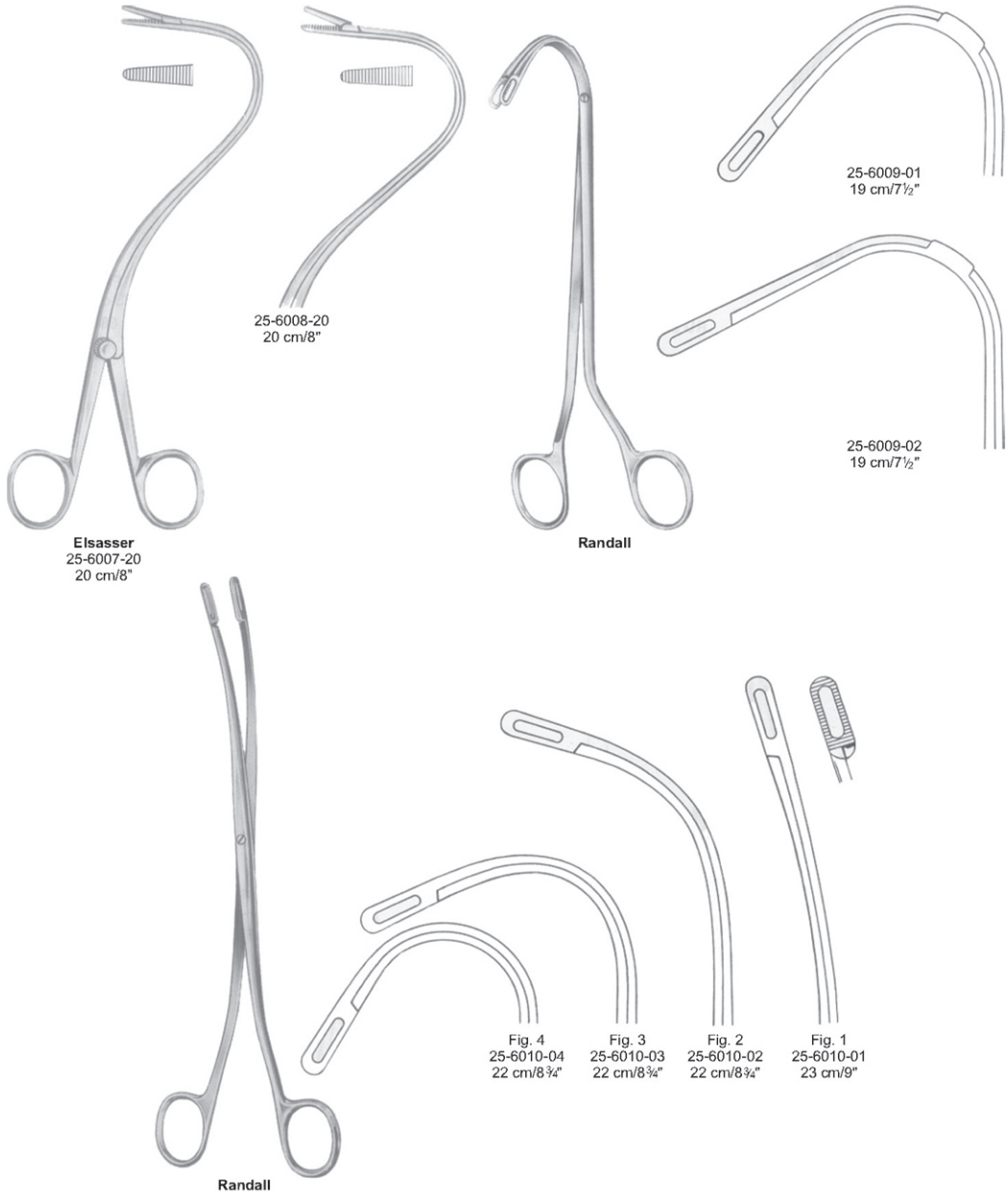

KIDNEY, UROLOGY INSTRUMENTS



Gray
 25-6011-00

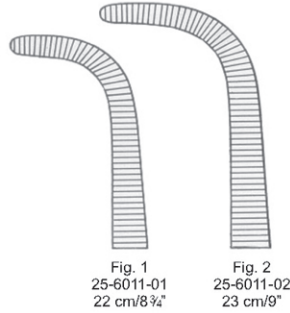

Set of 2 pieces



Gray
 25-6012-00

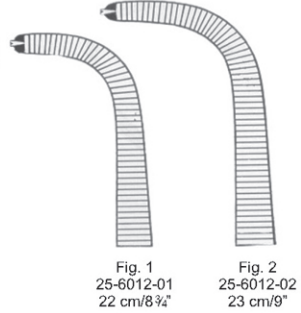

Set of 2 pieces

Gall duct and
 cystic forceps



Desjardins
 25-6013-21
 21 cm/8 1/4"



Nissen
 25-6014-21
 21.5 cm/8 1/2"

KIDNEY, UROLOGY INSTRUMENTS



Straight **Blake** Curved
25-6015-20 20 cm/8" 25-6016-20



Straight **Mayo-Blake** Curved
25-6017-20 20 cm/8" 25-6018-20



Czerny
25-6019-24
24.5 cm/9 3/4"



Desjardins
23 cm/9"



Fig. 1
25-6020-01



Fig. 2
25-6021-02



KIDNEY, UROLOGY INSTRUMENTS



mm	
1	25-6025-01
2	25-6025-02
3	25-6025-03
4	25-6025-04
5	25-6025-05
6	25-6025-06
7	25-6025-07
8	25-6025-08
9	25-6025-09
10	25-6025-10
11	25-6025-11
12	25-6025-12
13	25-6025-13

25-6025-00
set of 9 pieces

25-6025-03 to 25-6025-11

25-6026-00
set of 9 pieces in canvas pocket

Elastic



Desjardins
30 cm/12"



Fig.1
25-6027-01



Fig.2
25-6027-02



Fig.3
25-6027-03



Fig.4
25-6027-04

Malleable



Luer-Koerte
32 cm/12½"



25-6028-02
2.5 mm



25-6028-03
3.2 mm



25-6028-04
4.2 mm



25-6028-05
5.5 mm



25-6028-06
6.7 mm



25-6028-08
8.0 mm



25-6028-11
11 mm



25-6028-15
15 mm

KIDNEY, UROLOGY INSTRUMENTS



Mayo
 25-6029-28
 28 cm/11"

Malleable



Fig. 1
 25-6030-01



Fig. 2
 25-6030-02



Fig. 3
 25-6030-03



Moore
 26-08506-28
 28 cm/11"

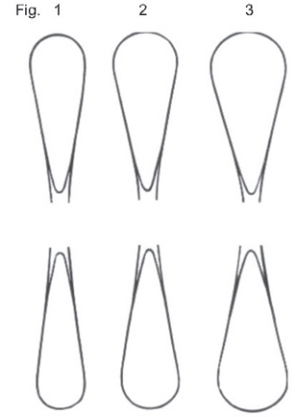
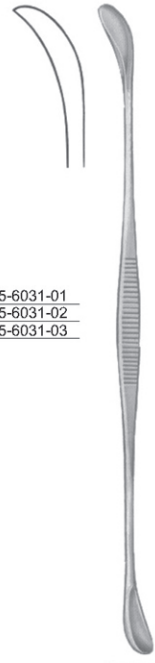

Fig.
 1 25-6031-01
 2 25-6031-02
 3 25-6031-03



Ferguson
 24 cm/9½"

KIDNEY, UROLOGY INSTRUMENTS



Young
 25-6032-21
 21 cm/8 1/4"



Young
 25-6033-22
 22 cm/8 3/4"



Young
 25-6034-21
 21 cm/8 1/4"



Young
 25-6035-22
 22 cm/8 3/4"



Millin
 25-6036-23
 23 cm/9"



Millin
 25-6037-23
 23 cm/9"



Millin
 25-6038-23
 23 cm/9"

KIDNEY, UROLOGY INSTRUMENTS



Millin
 25-6039-24
 24 cm/9½"

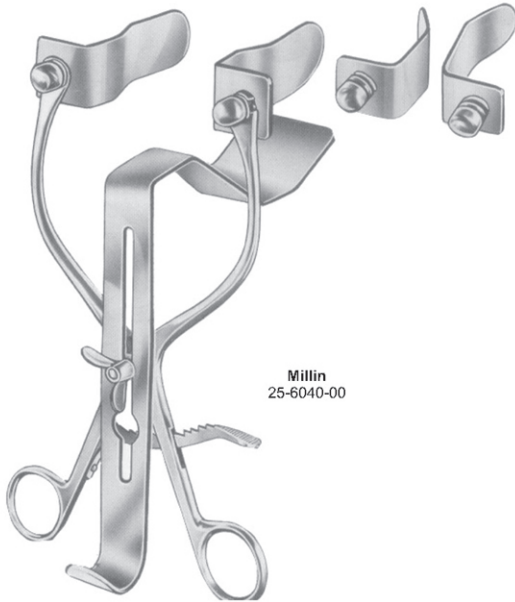

Millin
 25-6040-00



Legueu
 25-6041-00

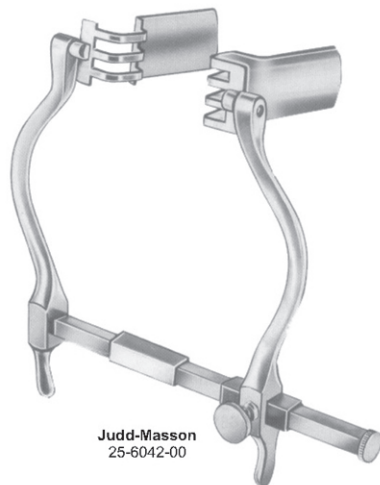

Judd-Masson
 25-6042-00

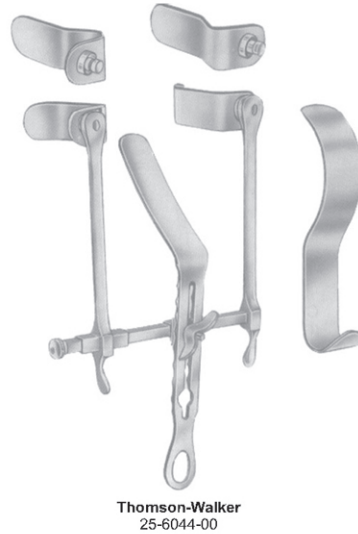
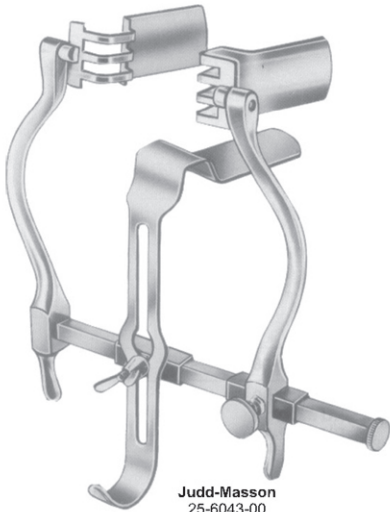



KIDNEY, UROLOGY INSTRUMENTS

mm Ø	Charriere (French)
2 ² / ₃	8
3	9
3 ¹ / ₂	10
3 ² / ₃	11
4	12
4 ¹ / ₂	13
4 ² / ₃	14
5	15
5 ¹ / ₂	16
5 ² / ₃	17
6	18
6 ¹ / ₂	19
6 ² / ₃	20
7	21
7 ¹ / ₂	22
7 ² / ₃	23
8	24
8 ¹ / ₂	25
8 ² / ₃	26
9	27
9 ¹ / ₂	28
9 ² / ₃	29
10	30
10 ¹ / ₂	32
11 ¹ / ₂	34
12	36



Van Buren
 Charrier (French)
 No. 8-36
 25-6047-08
 25-6047-36
 28 cm/11"
 In Canvas Pouch
 25-6047-50
 Set of 6
 6 Pcs. 25-6047-14/24
 25-6047-24
 25-6047-60
 Set of 12
 12 Pcs 25-6047-08/36
 25-6047-36

25-6047-08
25-6047-10
25-6047-12
25-6047-14
25-6047-16
25-6047-18
25-6047-20
25-6047-22
25-6047-24
25-6047-26
25-6047-28
25-6047-30
25-6047-32
25-6047-34
25-6047-36



Dittel
 Charriere (French)
 No. 8-30
 25-6048-08
 25-6048-30
 19.5 cm/7¹/₂"

Straight
25-6048-08
25-6048-09
25-6048-10
25-6048-11
25-6048-12
25-6048-13
25-6048-14
25-6048-15
25-6048-16
25-6048-17
25-6048-18
25-6048-19
25-6048-20
25-6048-21
25-6048-22
25-6048-23
25-6048-24
25-6048-25
25-6048-26
25-6048-27
25-6048-28
25-6048-26
25-6048-30



Dittel
 Charriere (French)
 No. 8-30
 25-6049-08
 25-6049-30
 34.5 cm/13¹/₂"

Curved
25-6049-08
25-6049-09
25-6049-10
25-6049-11
25-6049-12
25-6049-13
25-6049-14
25-6049-15
25-6049-16
25-6049-17
25-6049-18
25-6049-19
25-6049-20
25-6049-21
25-6049-22
25-6049-23
25-6049-24
25-6049-25
25-6049-26
25-6049-27
25-6049-28
25-6049-26
25-6049-30

KIDNEY, UROLOGY INSTRUMENTS

For men



25-6050-06
 25-6050-24

	mm Ø	Charriere (French)	
25-6050-06	2	6	25-6051-06
25-6050-07	2 1/8	7	25-6051-07
25-6050-08	2 2/8	8	25-6051-08
25-6050-09	3	9	25-6051-09
25-6050-10	3 1/8	10	25-6051-10
25-6050-11	3 2/8	11	25-6051-11
25-6050-12	4	12	25-6051-12
25-6050-13	4 1/8	13	25-6051-13
25-6050-14	4 2/8	14	25-6051-14
25-6050-15	5	15	25-6051-15
25-6050-16	5 1/8	16	25-6051-16
25-6050-17	5 2/8	17	25-6051-17
25-6050-18	6	18	25-6051-18
25-6050-19	6 1/8	19	25-6051-19
25-6050-20	6 2/8	20	25-6051-20
25-6050-21	7	21	25-6051-21
25-6050-22	7 1/8	22	25-6051-22
25-6050-23	7 2/8	23	25-6051-23
25-6050-24	8	24	25-6051-24

For Women



Catheter Introducing Instruments



Guyon
 25-6052-39
 39 cm/15 1/2"



Guyon
 25-6053-35
 35 cm/13 3/4"

KIDNEY, UROLOGY INSTRUMENTS

Circumcision Instruments

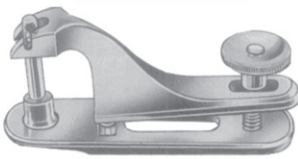

25-6054-08	08 mm
25-6054-11	11 mm
25-6054-13	13 mm
25-6054-16	16 mm
25-6054-21	21 mm
25-6054-26	26 mm
25-6054-32	32 mm

Foreign Body Forceps



Mathieu
25-6055-20

Penis Clamps

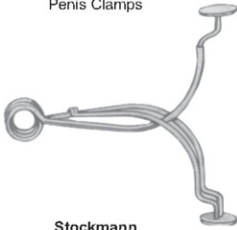

Stockmann
25-6056-00



Strauss
25-6057-00

Secretion Scoop



Guttman
25-6058-26
26.5 cm/10½"