

EN Gynecology

DE Gynäkologie

ES Ginecología

Page 519 to 558



Scheme of Dimensions for Specula

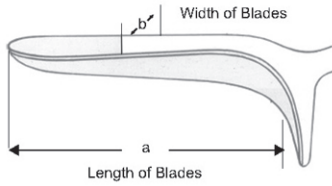

	a mm	b mm
26-6101-01	75	32
26-6101-02	85	35
26-6101-03	100	37

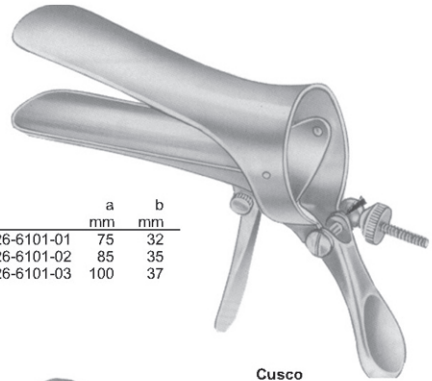

Cusco

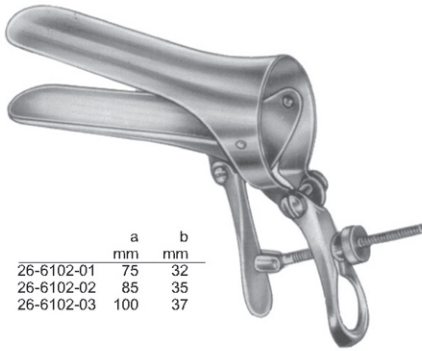

	a mm	b mm
26-6102-01	75	32
26-6102-02	85	35
26-6102-03	100	37

Cusco

For Virgins	a mm	b mm
26-6103-00	75	17



Cusco

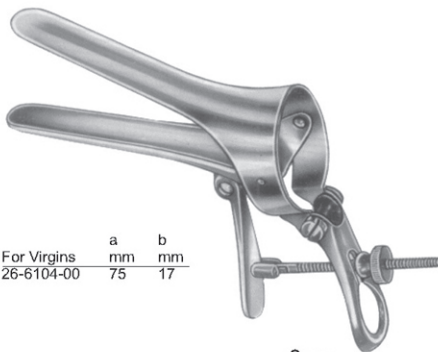

For Virgins	a mm	b mm
26-6104-00	75	17

Cusco

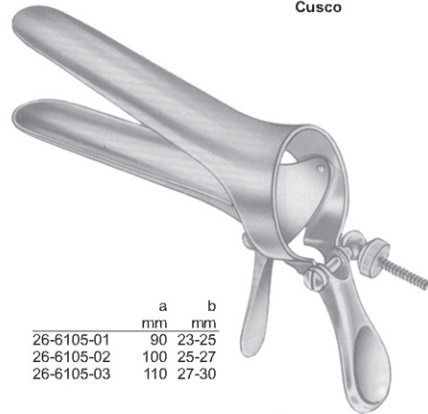

	a mm	b mm
26-6105-01	90	23-25
26-6105-02	100	25-27
26-6105-03	110	27-30

Cusco  
Swiss Pattern

**GYNECOLOGY**

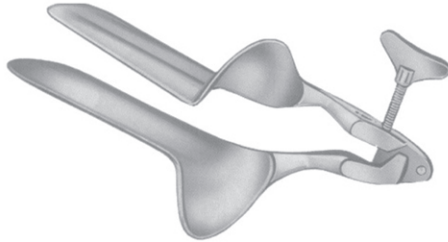

**Collin-Landau**

Small	26-6106-01	30 x 85 mm
Medium	26-6106-02	35 x 100 mm
Large	26-6106-03	40 x 110 mm



**Collin**

Small	26-6107-01	30 x 85 mm
Medium	26-6107-02	35 x 100 mm
Large	26-6107-03	40 x 110 mm

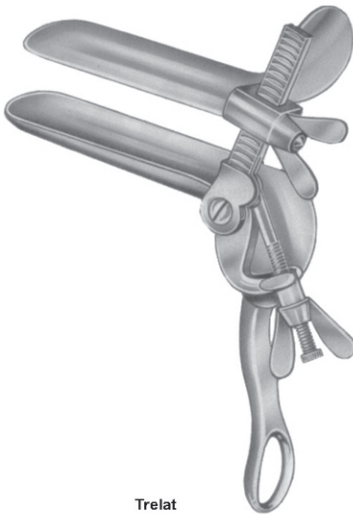

**Tretat**

	a mm	b mm
26-6108-01	85	33
26-6108-02	95	35
26-6108-03	115	43



**Grave (Standard)**

	a mm	b mm
26-6109-01	75	20
26-6109-02	95	30
26-6109-03	115	35
26-6109-04	125	35

**GYNECOLOGY**

**Black**



Grave	a mm	b mm
26-6110-01	75	20
26-6110-02	95	35
26-6110-03	115	35

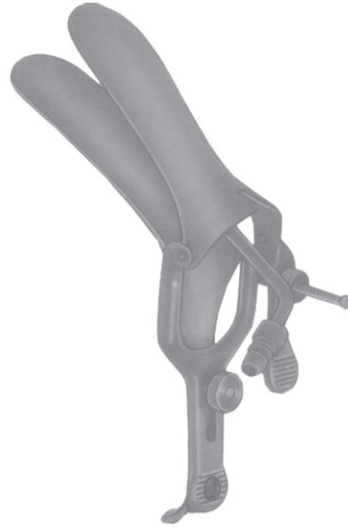

Grave Angled 135°	a mm	b mm
26-6111-00	101	35

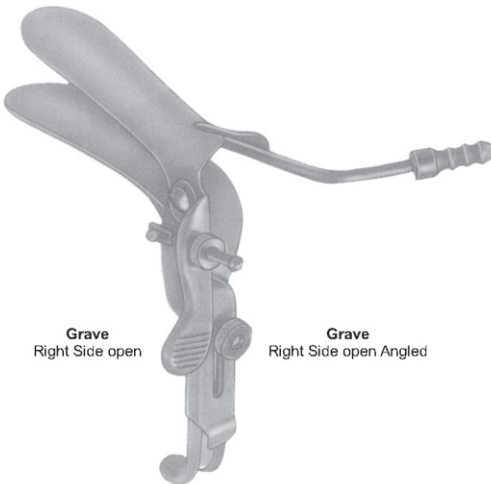

**Grave**  
Right Side open

**Grave**  
Right Side open Angled

	a mm	b mm
26-6112-01	101	35
26-6112-02	101	35

**Lateral Specula**



26-6113-00

GYNECOLOGY



**Pederson**

	a mm	b mm
26-6114-01	75	13
26-6114-02	100	22
26-6114-03	120	25

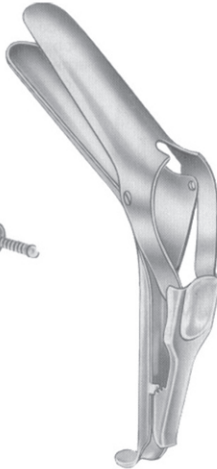

**Semm**

	a mm	b mm
26-6115-01	90	14/18
26-6115-02	100	17/20
26-6115-03	100	25/30



**Nott**

	a mm	b mm
26-6116-01	90	30
26-6116-02	110	30

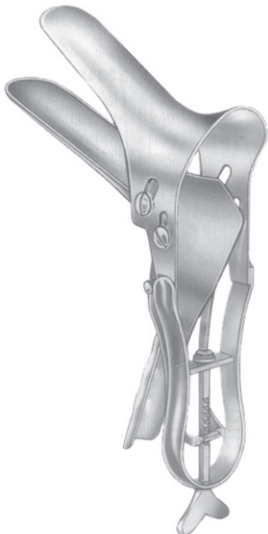

**Seyffert**

	a mm	b mm
26-6117-01	100	17
26-6117-02	110	33

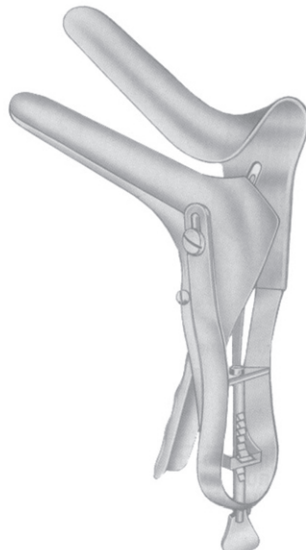

One Side open

**Seyffert**

	a mm	b mm
26-6118-02	110	33

Scheme of Dimensions for Specula

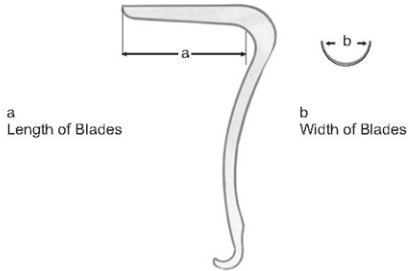

**Sims (single ended)**  
26-6119-01 63 x 32 mm  
26-6119-02 76 x 32 mm  
26-6119-03 89 x 38 mm

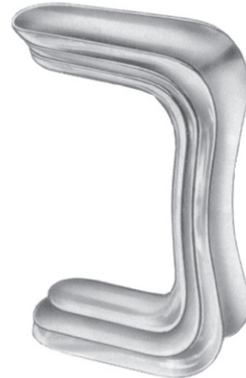

**Sims (double ended)**  
26-6120-01 26 x 70 mm (30 x 75 mm)  
26-6120-02 30 x 75 mm (35 x 80 mm)  
26-6120-03 36 x 80 mm (40 x 90 mm)



**Jackson**

Fig.	a mm	b mm
26-6121-01	1 75	40
26-6121-02	2 90	40
26-6121-03	3 100	40



**Eastman**

Fig.	a mm	b mm
26-6122-01	1 76	38
26-6122-02	2 89	38
26-6122-03	3 101	38

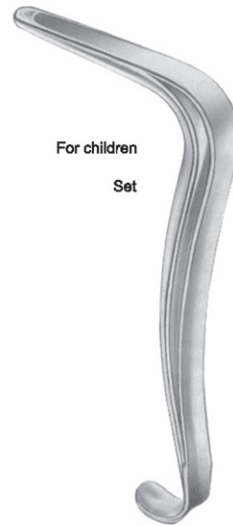

**Kristeller**  
26-6123-00  
70x15 mm

**GYNECOLOGY**

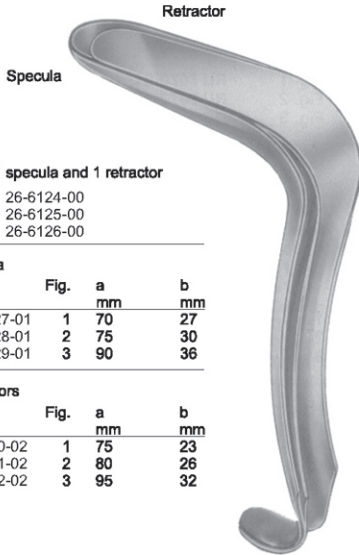

**Retractor**

**Specula**

Set of 1 specula and 1 retractor

Fig. 1 26-6124-00  
 Fig. 2 26-6125-00  
 Fig. 3 26-6126-00

Specula	Fig.	a mm	b mm
26-6127-01	1	70	27
26-6128-01	2	75	30
26-6129-01	3	90	36

Retractors	Fig.	a mm	b mm
26-6130-02	1	75	23
26-6131-02	2	80	26
26-6132-02	3	95	32

**Kristeller (Standard)**

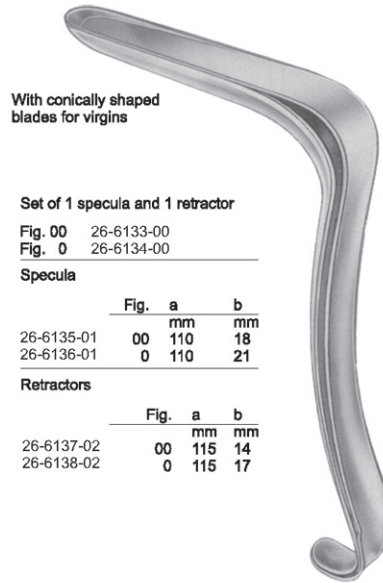

**With conically shaped blades for virgins**

Set of 1 specula and 1 retractor

Fig. 00 26-6133-00  
 Fig. 0 26-6134-00

Specula	Fig.	a mm	b mm
26-6135-01	00	110	18
26-6136-01	0	110	21

Retractors	Fig.	a mm	b mm
26-6137-02	00	115	14
26-6138-02	0	115	17

**Kristeller**

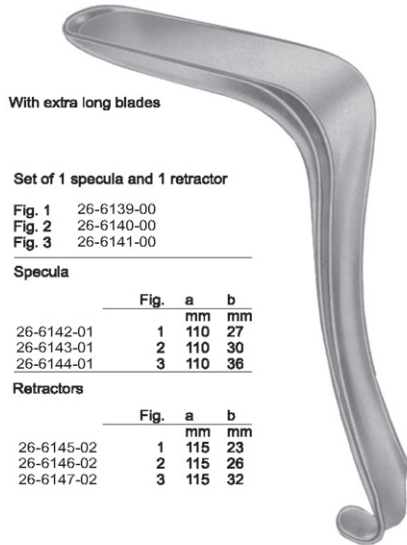

**With extra long blades**

Set of 1 specula and 1 retractor

Fig. 1 26-6139-00  
 Fig. 2 26-6140-00  
 Fig. 3 26-6141-00

Specula	Fig.	a mm	b mm
26-6142-01	1	110	27
26-6143-01	2	110	30
26-6144-01	3	110	36

Retractors	Fig.	a mm	b mm
26-6145-02	1	115	23
26-6146-02	2	115	26
26-6147-02	3	115	32

**Kristeller (Standard)**

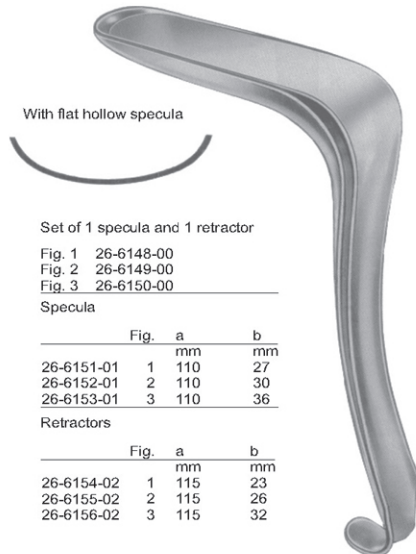

**With flat hollow specula**

Set of 1 specula and 1 retractor

Fig. 1 26-6148-00  
 Fig. 2 26-6149-00  
 Fig. 3 26-6150-00

Specula	Fig.	a mm	b mm
26-6151-01	1	110	27
26-6152-01	2	110	30
26-6153-01	3	110	36

  

Retractors	Fig.	a mm	b mm
26-6154-02	1	115	23
26-6155-02	2	115	26
26-6156-02	3	115	32

**Kristeller**

GYNECOLOGY

	a mm	b mm
26-6157-20	100	20
26-6157-25	100	25
26-6157-30	100	30
26-6157-35	100	35
26-6157-40	100	40
26-6158-20	130	20
26-6158-25	130	25
26-6158-30	130	30
26-6158-35	130	35
26-6158-40	130	40

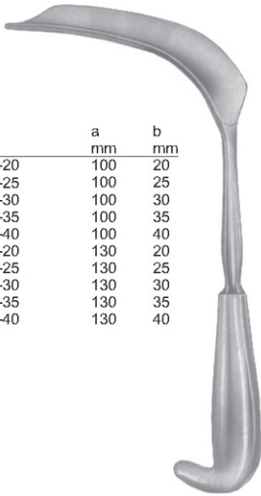

**Matzenauer**



**Braun**  
26-6159-18  
18 cm/7"  
56x13 mm



**Braun**  
26-6160-18  
18 cm/7"  
60x10 mm



**Ulrich**  
26-6161-19  
19.5 cm/7½"  
80x20 mm



**Ulrich**  
26-6162-19  
19 cm/7½"  
85x17 mm

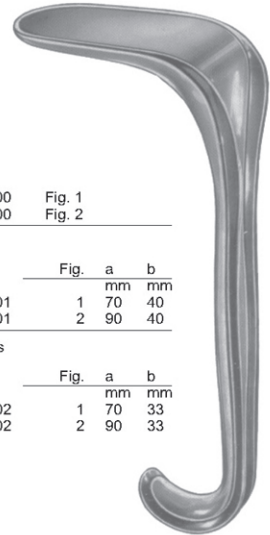

Set

26-6163-00	Fig. 1
26-6164-00	Fig. 2

Specula

	Fig.	a mm	b mm
26-6165-01	1	70	40
26-6166-01	2	90	40

Retractors

	Fig.	a mm	b mm
26-6167-02	1	70	33
26-6168-02	2	90	33



GYNECOLOGY

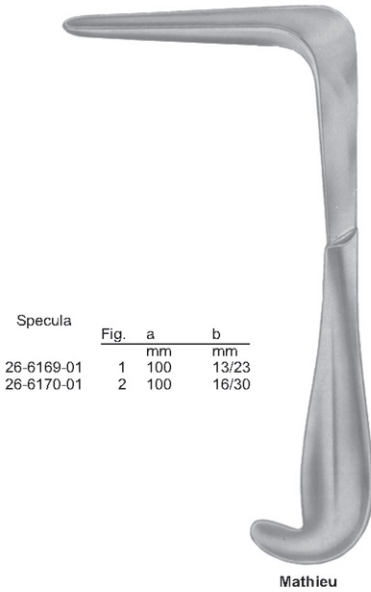

Specula	Fig.	a		b	
		mm	mm	mm	mm
26-6169-01	1	100	13/23		
26-6170-01	2	100	16/30		

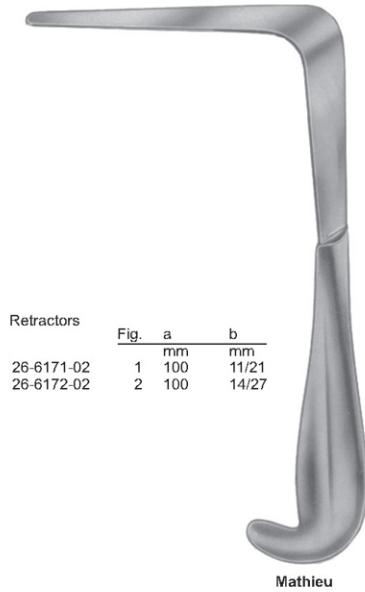

Retractors	Fig.	a		b	
		mm	mm	mm	mm
26-6171-02	1	100	11/21		
26-6172-02	2	100	14/27		



Fig.	a		b	
	mm	mm	mm	mm
26-6173-01	1	75	45	
26-6173-02	2	90	45	
26-6173-03	3	110	45	



26-6174-01	75 x 280mm
26-6174-02	90 x 280mm
26-6174-03	100 x 280mm
26-6174-03	115 x 280mm



Doyen 24 cm/9 1/2"			Doyen 24 cm/9 1/2"		
	Fig.	a mm	b mm		
slightly-concave				Medium-concave	
26-6175-01	1	55	35	26-6178-01	
26-6175-02	2	85	35	26-6178-02	
26-6175-03	3	115	35	26-6178-03	
26-6176-01	1	55	45	26-6179-01	
26-6176-02	2	85	45	26-6179-02	
26-6176-03	3	115	45	26-6179-03	
26-6176-04	4	160	45		
26-6176-05	5	180	45		
26-6177-01	1	55	60	26-6180-01	
26-6177-02	2	85	60	26-6180-02	
26-6177-03	3	115	60	26-6180-03	
26-6177-04	4	160	60		
26-6177-05	5	180	60		

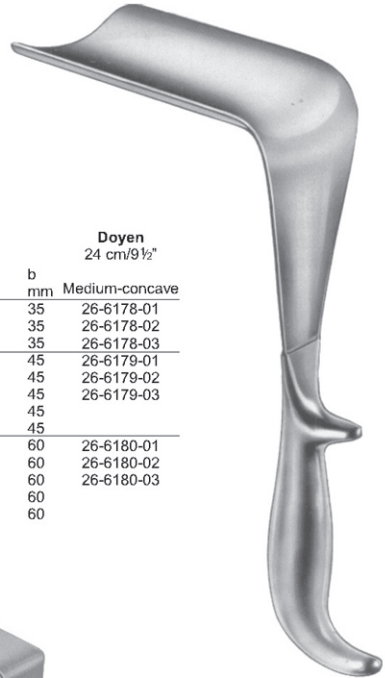

Doyen  
25 cm/10"

	a mm	b mm
26-6181-01	60	30
26-6181-02	70	30
26-6181-03	80	30



GYNECOLOGY



**Auvard**  
 with removable weight  
 26-6182-01  
 80x38 mm  
 26-6182-02  
 105x42 mm



**Auvard**  
 with fixed weight  
 26-6183-01  
 70x38 mm  
 26-6183-02  
 102x45 mm



**Landau**

	a mm	b mm
26-6184-01	100	28
26-6184-02	100	38



**Breisky**

	a mm	b mm
26-6185-20	100	20
26-6185-25	100	25
26-6185-30	100	30
26-6185-35	100	35
26-6185-40	100	40
26-6186-20	130	20
26-6186-25	130	25
26-6186-30	130	30
26-6186-35	130	35
26-6186-40	130	40
26-6187-20	160	20
26-6187-25	160	25
26-6187-30	160	30
26-6187-35	160	35
26-6187-40	160	40
26-6188-20	180	20
26-6188-25	180	25
26-6188-30	180	30
26-6188-35	180	35
26-6188-40	180	40

GYNECOLOGY



**Gelpi**  
Vulva self retaining  
26-6189-20 20cm/8"



**Comyn Berkeley**  
Vulva self retaining  
26-6190-15 15.5cm/6"

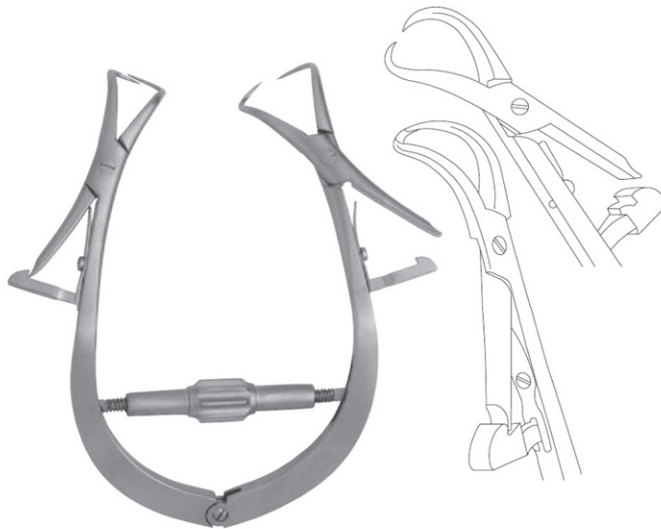

**Joll**  
Thyroid self retaining  
26-6191-15 15.5cm/6"

## GYNECOLOGY

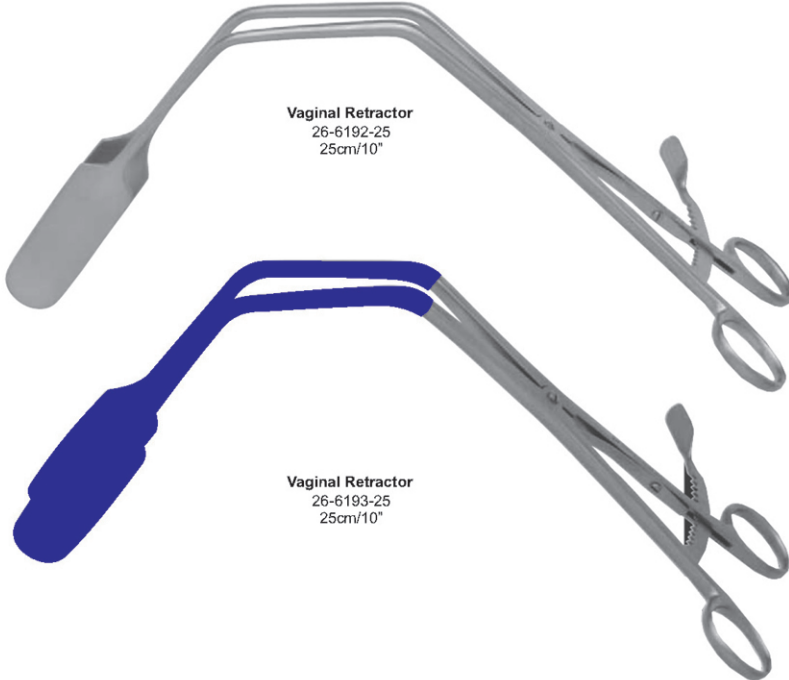
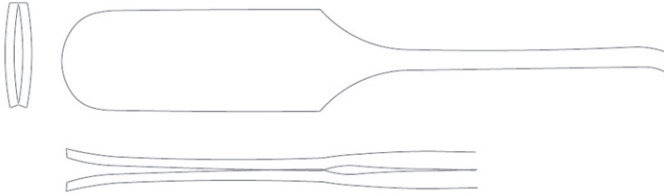

**Vaginal Retractor**  
26-6192-25  
25cm/10"

**Vaginal Retractor**  
26-6193-25  
25cm/10"

GYNECOLOGY



Complete



26-6194-01  
80x30 mm



26-6194-02  
85x35 mm

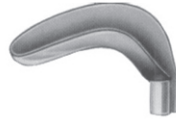

26-6194-03  
90x40 mm



26-6194-04  
55x40/60 mm



26-6194-05  
70x45/70 mm

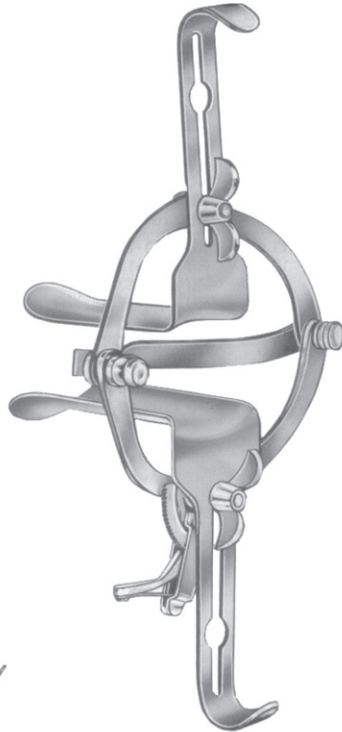

**O'Sullivan-O'Connor**  
26-6195-00  
Complete

Fig.	a mm	b mm	
26-6195-01	1	45	17
26-6195-02	2	90	37
26-6195-03	3	90	45

GYNECOLOGY



**Hegar**  
 single ended  
 18.5 cm long

mm Ø	
2.0	26-6196-02
3.0	26-6196-03
4.0	26-6196-04
5.0	26-6196-05
6.0	26-6196-06
7.0	26-6196-07
8.0	26-6196-08
9.0	26-6196-09
10.0	26-6196-10
11.0	26-6196-11
12.0	26-6196-12
13.0	26-6196-13
14.0	26-6196-14
15.0	26-6196-15
16.0	26-6196-16
17.0	26-6196-17
18.0	26-6196-18
19.0	26-6196-19
20.0	26-6196-20
21.0	26-6196-21
22.0	26-6196-22
23.0	26-6196-23
24.0	26-6196-24
25.0	26-6196-25
26.0	26-6196-26

Pieces per set

26-6197-50	12	3 - 14 mm
26-6198-60	25	2 - 26 mm



**Hegar**  
 double ended  
 20 cm long

Ø mm	
1/2	26-6199-02
3/4	26-6199-04
5/6	26-6199-06
7/8	26-6199-08
9/10	26-6199-10
11/12	26-6199-12
13/14	26-6199-14
15/16	26-6199-16
17/18	26-6199-18
19/20	26-6199-20
21/22	26-6199-22
23/24	26-6199-24
25/26	26-6199-26

Pieces per set

set	
26-6200-00	08 3/4 - 17/18 mm
26-6200-00	12 1/2 - 23/24 mm



mm	
3/6	26-6202-03
4/7	26-6202-04
5/8	26-6202-05
6/9	26-6202-06
7/10	26-6202-07
8/11	26-6202-08
9/12	26-6202-09
10/13	26-6202-10
11/14	26-6202-11
12/15	26-6202-12
13/16	26-6202-13
14/17	26-6202-14
15/18	26-6202-15
16/19	26-6202-16
17/20	26-6202-17
18/21	26-6202-18

**Hawkin Ambler**  
 26-6201-16  
 17 cm long  
 set of 16 3/6 - 18/21



**Hank**  
 26-6203-30

mm	
9/10	26-6204-10
11/12	26-6204-12
13/14	26-6204-14
15/16	26-6204-16
17/18	26-6204-18
19/20	26-6204-20

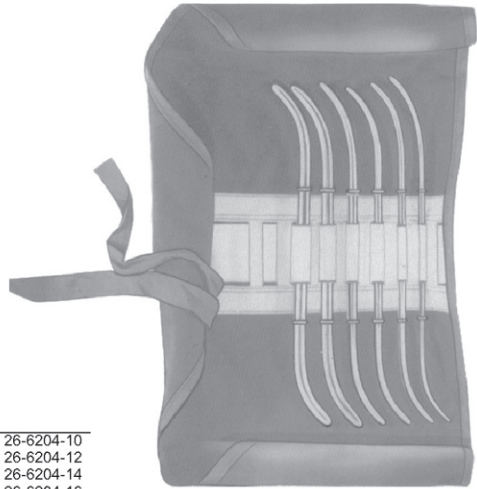

**Set**  
 26-6205-00  
 double ended  
 27 cm



**Pratt**

mm	
13/15	26-6206-15
17/19	26-6206-19
21/23	26-6206-23
25/27	26-6206-27
29/31	26-6206-31
33/35	26-6206-35
37/39	26-6206-39
41/43	26-6206-43

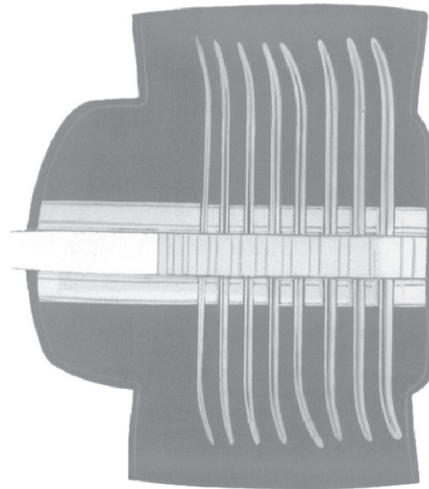

**Set**  
 26-6207-00  
 double ended  
 29 cm



GYNECOLOGY

Tip 4 mm



**Sims**  
32 cm/12½"



**Martin (Simpson)**  
32 cm/12½"



**Valleix**  
26-6214-25  
25 cm/10"



**Collin**  
26-6215-28  
28 cm/11"



**Braun**  
26-6216-28  
28 cm/11"

Uterine Depressor

Rigid	cm	cm
	26-6208-32	26-6211-32

Malleable	cm / in	cm / in
	26-6209-32	26-6212-32
	26-6210-32	26-6213-32

**GYNECOLOGY**

Laser Probes

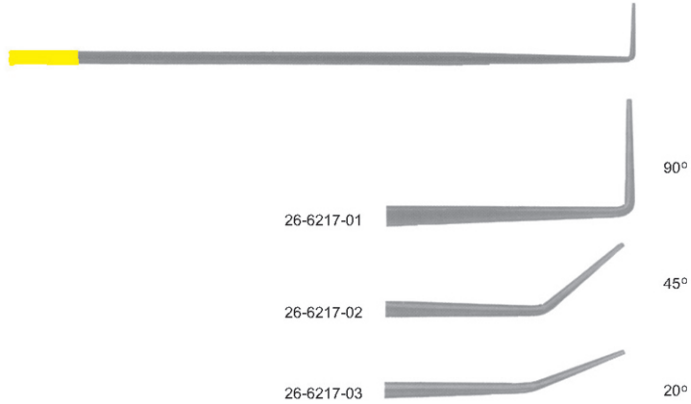

Measuring Probe

26-6218-01

Laser Probe

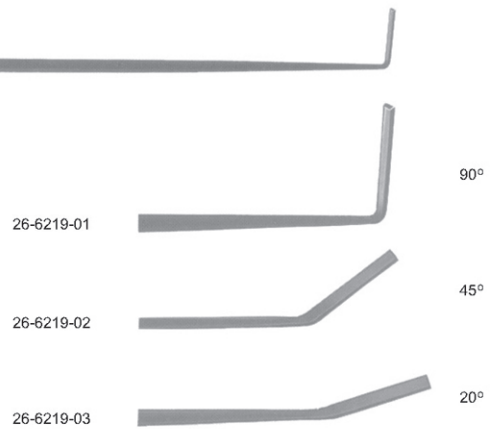

Depth Ruler

26-6220-01

**GYNECOLOGY**

**Measuring Instruments**

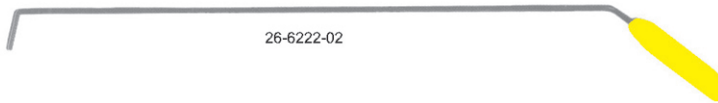
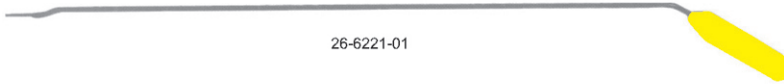

**Hooks**

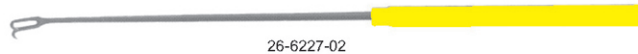
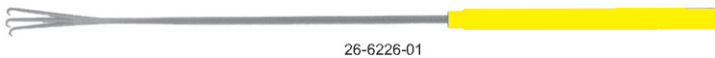
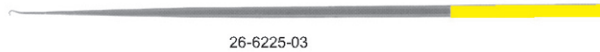
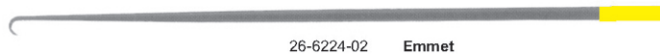
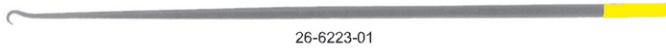

GYNECOLOGY



**Ayre**  
26-6228-23  
23 cm/9"



**Simon**  
26-6229-22  
22 cm/8¾"



**Simon**  
26-6230-22  
22 cm/8¾"



**Emmet**  
22 cm/8¾"



26-6231-01



26-6231-02



26-6231-03



26-6231-04



26-6231-05



**Doyen**  
26-6232-17  
17 cm/6¾"



**Doyen**  
26-6233-17  
17 cm/6¾"



**Segond**  
26-6234-27  
27 cm/10½"



GYNECOLOGY

Secretion Spoon



26-6235-27  
 27 cm/10½"



Muenchen  
 27 cm/10½"



26-6236-04  
 4 mm



26-6236-05  
 5 mm



Randall  
 26-6237-24  
 24 cm/9½"

4 mmØ



Novak  
 23 cm/9"

- 26-6238-01  
1 mm
- 26-6238-02  
2 mm
- 26-6238-03  
3 mm
- 26-6238-04  
4 mm



Novak-Schoeckaert  
 26-6239-24  
 24 cm/9"

GYNECOLOGY



**Kevorkian**  
26-6240-30  
30 cm/12"

malleable  
26-6241-30  
30 cm/12"



**Kevorkian**  
26-6242-30  
30 cm/12"

malleable  
26-6243-30  
30 cm/12"



**Townsend**  
26-6244-30  
31 cm/12¼"

malleable  
26-6245-30  
31 cm/12¼"



**Duncan**  
26-6246-31  
31 cm/12¼"



**Duncan**  
26-6247-31  
31 cm/12¼"

GYNECOLOGY



**Goodell**  
 26-6248-34  
 34 cm/13½"



**Kogan-Laser**  
 28 cm/11"



26-6251-28  
 28 cm/11"



**Kogan**  
 26-6252-24  
 24 cm/9½"

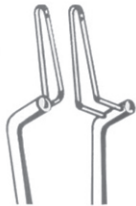

**Kogan**  
 26-6253-24  
 24 cm/9½"



**Kogan**  
 28 cm/11"



GYNECOLOGY



**Martin**  
26-6256-27  
27 cm/10½"

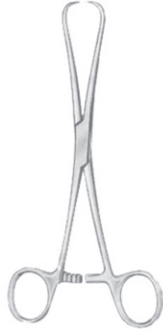

**Staude-Moore**  
26-6257-17  
17 cm/6¾"



**Barrett**  
26-6258-18  
18 cm/7"



**Schroeder**  
26-6259-25  
25 cm/10"



**Braun**  
26-6260-25  
25 cm/10"



**Collin-Pozzi**  
26-6261-25  
25 cm/10"



**Pozzi**  
26-6262-25  
25.5 cm/10¼"

Strong Pattern



**Duplay**  
26-6263-28  
28 cm/11"



GYNECOLOGY

Amniotome for the amnion Bladder



**Skene**  
 26-6264-24  
 24 cm/9½"



**Becham**  
 26-6265-26  
 26 cm/10¼"



**Czerny**  
 26-6266-20  
 20.5 cm/8¼"



26-6267-26  
 26 cm/10¼"



**Schroeder**  
 26-6268-20 20 cm/8"  
 26-6268-24 24 cm/9½"

Straight



**Schroeder**  
 26-6269-20  
 26-6269-24

Curved on Flat



**Schroeder**  
 26-6270-20  
 26-6270-24

Curved Sideway

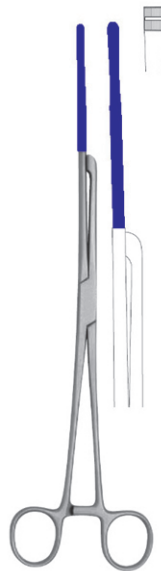

**Atrauma**  
 26-6271-29  
 Vulsellum Forcep  
 29cm/11 ½"

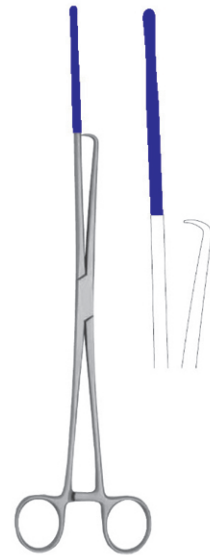

**Luer**  
 26-6272-30  
 Vulsellum Forceps  
 30.5cm/12"

GYNECOLOGY



**Atrauma**  
26-6273-29  
29cm/11 1/2"



**Bozeman**  
26-6274-27  
27cm/10 1/2"

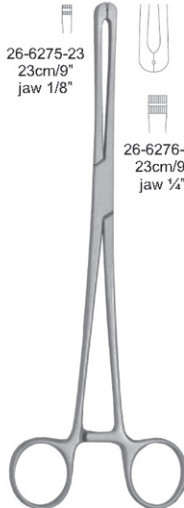

26-6275-23  
23cm/9"  
jaw 1/8"

26-6276-23  
23cm/9"  
jaw 1/4"



**Rotunda**  
26-6277-27  
27cm/10 1/2"



**Bierer**  
26-6278-24  
24cm/9 1/2"



**Straight**  
26-6279-06  
26-6279-08  
26-6279-10



**Museux**  
24 cm/9 1/2"  
06 mm  
08 mm  
10 mm



**Curved Sideway**  
26-6280-06  
26-6280-08  
26-6280-10



**Straight**  
26-6281-06  
26-6281-08  
26-6281-10



**Museux**  
24 cm/9 1/2"  
06 mm  
08 mm  
10 mm



**Curved Sideway**  
26-6282-06  
26-6282-08  
26-6282-10



**Braun**  
26-6283-16  
16 cm/6 1/4"

## GYNECOLOGY

For the amnion Bladder



**Pratt**  
26-6284-28  
28 cm/11"



**Teale**  
26-6285-24  
24 cm/9½"



**Iowa**  
26-6286-26  
26 cm/10¼"



**Jacobs**  
Straight 26-6287-21  
Curved Sideway 26-6288-21  
21 cm/8¼"



**Bonney Polypus**  
26-6289-26  
24 cm/9 ½"



**Kelly**  
26-6290-32  
32 cm/12½"



**Heywood-Smith**  
26-6291-20  
20 cm/8"

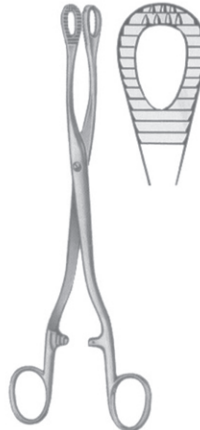

**Heywood-Smith**  
26-6292-25  
25 cm/10"



**Noto**  
26-6293-27  
27 cm/10½"

GYNECOLOGY



**Dartigues**  
26-6294-27  
27 cm/10½"



**Somer**  
26-6295-23  
23 cm/9"



**Collin**  
26-6296-25  
25 cm/10"



Ovarian Forceps  
**Doyen**  
26-6297-18 18 cm/7"  
26-6297-20 20 cm/8"



**Bonney**  
26-6298-34  
34.5 cm/13 ½"



**Bonney**  
26-6299-27  
27 cm/10½"



**Bonney**  
26-6300-20  
20 cm/8"  
curved



**Bonney Berkley**  
26-6301-20  
20 cm/8"  
angled

GYNECOLOGY



**Gellhorn**  
26-6302-23  
23 cm/9"



**Thoms-Gaylor**  
26-6303-24  
24 cm/9½"



**Schubert**  
26-6304-21 21 cm/8¼"  
26-6304-29 29 cm/11¼"



**Schubert**  
26-6305-26  
26 cm/10¼"



**Tischler**  
26-6306-27  
27 cm/10½"



**Van Doren**  
26-6307-25  
25 cm/10"



**Gwlliam**

26-6308-20 20cm/8"  
26-6309-20 20cm/8"



**Hunter**  
26-6310-23  
23 cm/9"

GYNECOLOGY

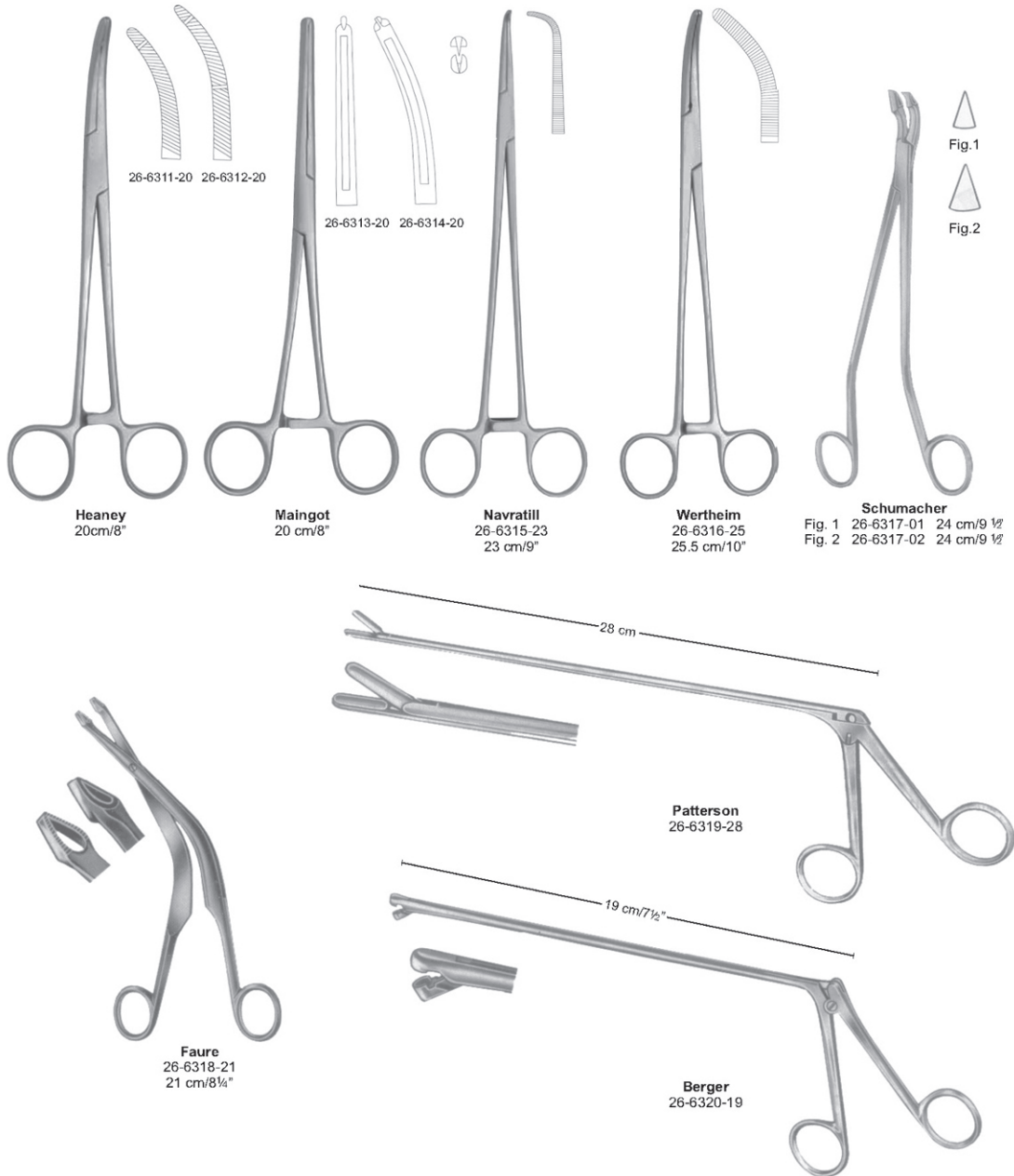

GYNECOLOGY



- 26-6321-20 L= 20 cm/8"
- 26-6321-25 L= 25 cm/10"
- 26-6321-30 L= 30 cm/12"
- 26-6321-35 L= 35 cm/14"
- 26-6321-40 L= 40 cm/16"



26-6323-04      26-6323-06  
 4 mm              6 mm

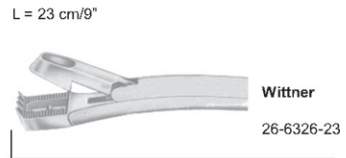
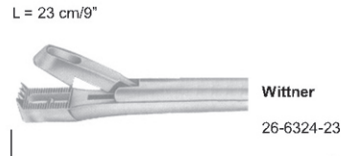

GYNECOLOGY

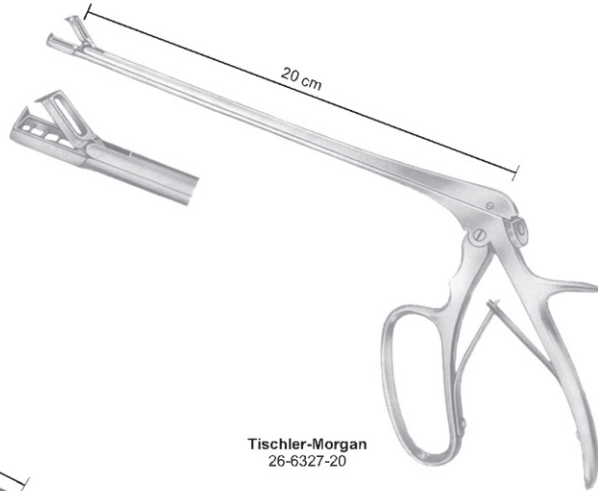

**Tischler-Morgan**  
26-6327-20

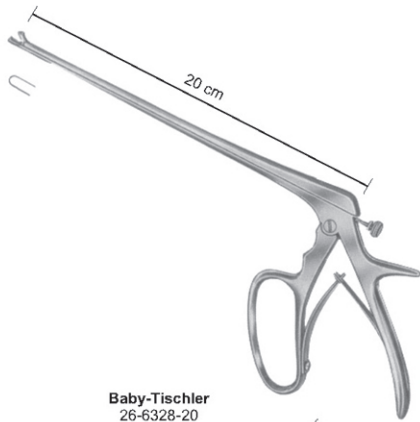

**Baby-Tischler**  
26-6328-20

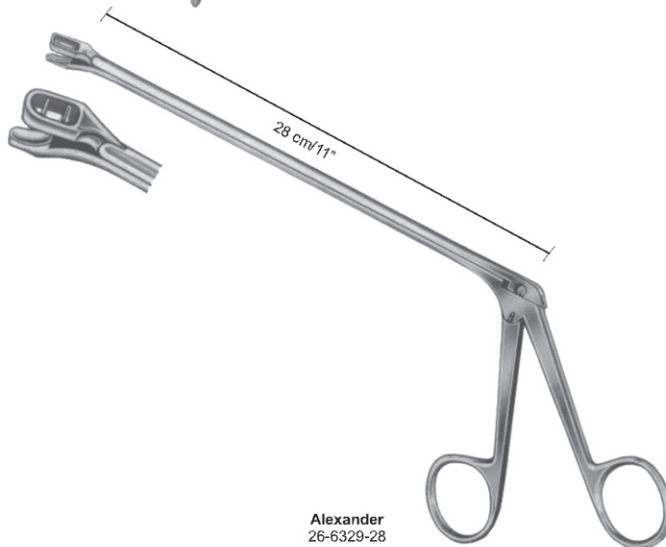

**Alexander**  
26-6329-28



GYNECOLOGY

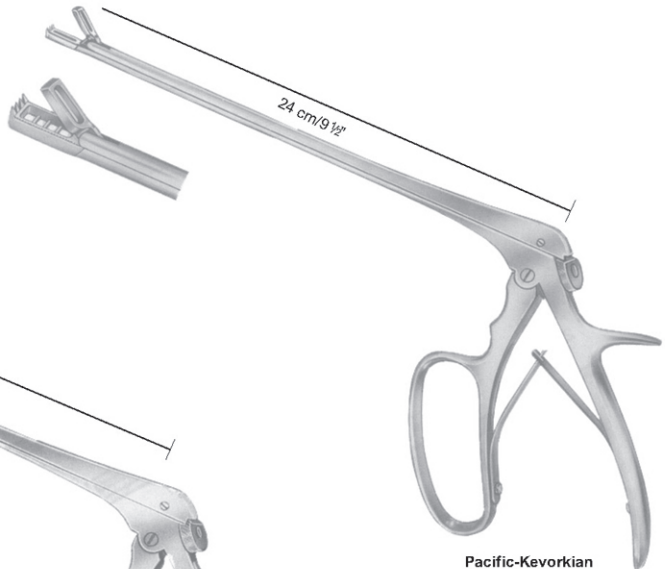

**Pacific-Kevorkian**  
26-6330-24

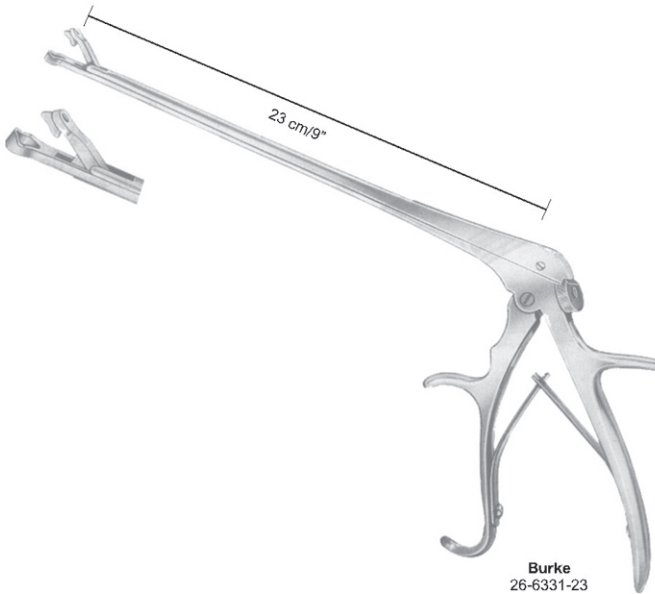

**Burke**  
26-6331-23

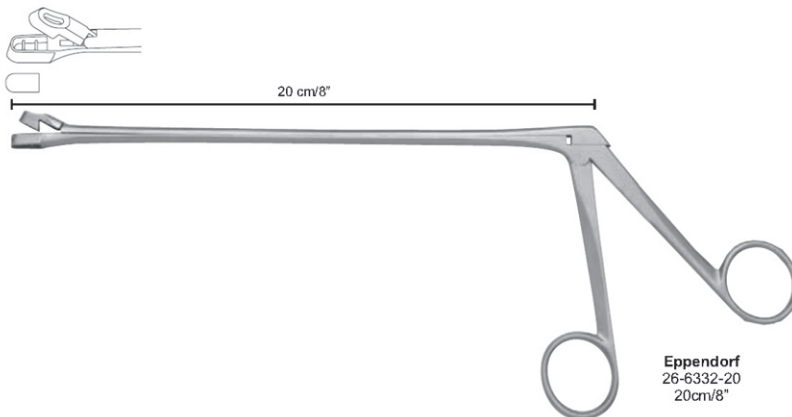

**Eppendorf**  
26-6332-20  
20cm/8"

GYNECOLOGY













Townsend

Handle

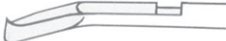

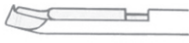
Tip with tube

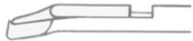
		Complete instrument	Tip, only
	<b>Tischler</b>	26-6333-00	26-6334-01
	<b>Kevorkian</b>	26-6335-00	26-6336-01
	<b>Mini-Townsend</b>	26-6337-00	26-6338-01
 	<b>Tischler-up</b>	26-6339-00	26-6340-01
 	<b>Tischler-down</b>	26-6341-00	26-6342-01
 	<b>Mini-Townsend-up</b>	26-6343-00	26-6344-01
 	<b>Mini-Townsend-down</b>	26-6345-00	26-6346-01

GYNECOLOGY



**Schroeder**  
30 cm/12"

Sharp Rigid



Fig. 1  
26-6347-01  
26-6348-01



Fig. 2  
26-6349-02  
26-6350-02



Fig. 3  
26-6351-03  
26-6352-03

Schroeder  
Simon



Fig. 4  
26-6353-04  
26-6354-04



Fig. 5  
26-6355-05  
26-6356-05



Fig. 6  
26-6357-06  
26-6358-06

Schroeder  
Simon



**Simon**  
25 cm/10"



**Gourdet**  
28 cm/11"



Fig. 1  
26-6359-01  
6 mm



Fig. 2  
26-6359-02  
8 mm



Fig. 3  
26-6359-03  
10 mm



Fig. 4  
26-6359-04  
12 mm



Fig. 5  
26-6359-05  
14 mm



**Thomas**



Fig. 1  
26-6360-01



Fig. 2  
26-6360-02



Fig. 3  
26-6360-03



Fig. 4  
26-6360-04



Fig. 5  
26-6360-05



Fig. 6  
26-6360-06



**Greene**

26-6361-10  
10 mm

26-6361-12  
12 mm

26-6361-14  
14 mm



**Collin**  
26-6362-30  
30 cm/12"



**Heaney**  
26-6363-24  
24 cm/9½"





**Heaney**  
26-6364-24  
24 cm/9½"

GYNECOLOGY



**Milan**  
28.5 cm/11¼"

			
Malleable	26-6365-05 5 mm Ø	26-6367-07 7 mm Ø	26-6369-09 9 mm Ø
Rigid	26-6366-05 5 mm Ø	26-6368-07 7 mm Ø	26-6370-09 9 mm Ø



28 cm/11"

Hose Connecting Piece



26-6372-00

	Ø
26-6371-04	4.0 mm
26-6371-06	6.0 mm
26-6371-08	8.0 mm
26-6371-10	10.0 mm
26-6371-12	12.0 mm
26-6371-14	14.0 mm
26-6371-16	16.0 mm



**Sims**  
25 cm/10"

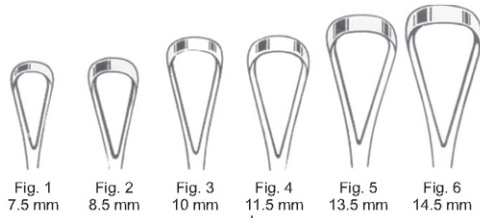

Malleable		Rigid	
Sharp	Blunt	Sharp	Blunt
Fig. 1 26-6373-01	26-6374-01	26-6375-01	26-6376-01
Fig. 2 26-6373-02	26-6374-02	26-6375-02	26-6376-02
Fig. 3 26-6373-03	26-6374-03	26-6375-03	26-6376-03
Fig. 4 26-6373-04	26-6374-04	26-6375-04	26-6376-04
Fig. 5 26-6373-05	26-6374-05	26-6375-05	26-6376-05
Fig. 6 26-6373-06	26-6374-06	26-6375-06	26-6376-06



**Sims**  
25 cm/10"

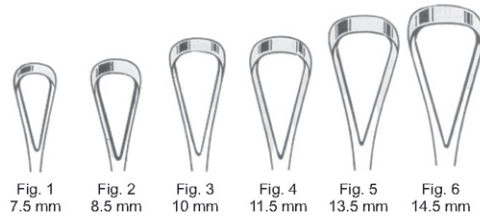

Malleable		Rigid	
Sharp	Blunt	Sharp	Blunt
Fig. 1 26-6377-01	26-6378-01	26-6379-01	26-6380-01
Fig. 2 26-6377-02	26-6378-02	26-6379-02	26-6380-02
Fig. 3 26-6377-03	26-6378-03	26-6379-03	26-6380-03
Fig. 4 26-6377-04	26-6378-04	26-6379-04	26-6380-04
Fig. 5 26-6377-05	26-6378-05	26-6379-05	26-6380-05
Fig. 6 26-6377-06	26-6378-06	26-6379-06	26-6380-06

GYNECOLOGY

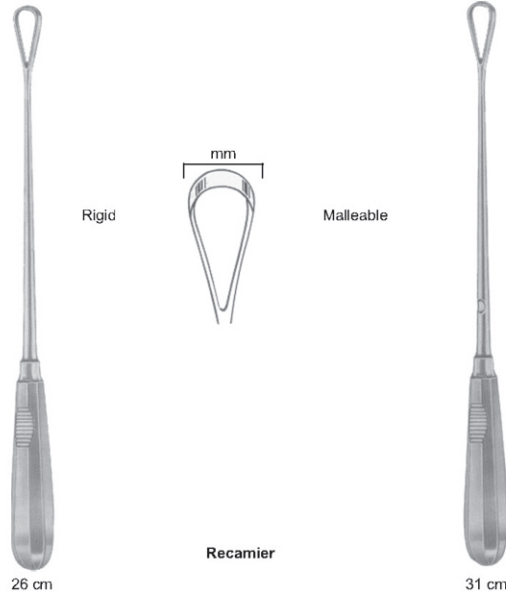

Fig.	mm	Malleable		Rigid		Malleable		Rigid	
		Sharp	Blunt	Sharp	Blunt	Sharp	Blunt	Sharp	Blunt
00	5	26-6381-05	26-6382-05	26-6383-05	26-6384-05	26-6385-05	26-6386-05	26-6387-05	26-6388-05
0	6	26-6381-06	26-6382-06	26-6383-06	26-6384-06	26-6385-06	26-6386-06	26-6387-06	26-6388-06
1	7	26-6381-07	26-6382-07	26-6383-07	26-6384-07	26-6385-07	26-6386-07	26-6387-07	26-6388-07
2	8	26-6381-08	26-6382-08	26-6383-08	26-6384-08	26-6385-08	26-6386-08	26-6387-08	26-6388-08
3	9	26-6381-09	26-6382-09	26-6383-09	26-6384-09	26-6385-09	26-6386-09	26-6387-09	26-6388-09
4	10	26-6381-11	26-6382-11	26-6383-11	26-6384-11	26-6385-11	26-6386-11	26-6387-11	26-6388-11
5	12	26-6381-12	26-6382-12	26-6383-12	26-6384-12	26-6385-12	26-6386-12	26-6387-12	26-6388-12
6	14	26-6381-14	26-6382-14	26-6383-14	26-6384-14	26-6385-14	26-6386-14	26-6387-14	26-6388-14
7	15	26-6381-15	26-6382-15	26-6383-15	26-6384-15	26-6385-15	26-6386-15	26-6387-15	26-6388-15
8	16	26-6381-16	26-6382-16	26-6383-16	26-6384-16	26-6385-16	26-6386-16	26-6387-16	26-6388-16
9	19	26-6381-19	26-6382-19	26-6383-19	26-6384-19	26-6385-19	26-6386-19	26-6387-19	26-6388-19
10	20	26-6381-20	26-6382-20	26-6383-20	26-6384-20	26-6385-20	26-6386-20	26-6387-20	26-6388-20
11	21	26-6381-21	26-6382-21	26-6383-21	26-6384-21	26-6385-21	26-6386-21	26-6387-21	26-6388-21
12	23	26-6381-23	26-6382-23	26-6383-23	26-6384-23	26-6385-23	26-6386-23	26-6387-23	26-6388-23
13	25					26-6385-25	26-6386-25	26-6387-25	26-6388-25
14	30					26-6385-30	26-6386-30	26-6387-30	26-6388-30
15	35					26-6385-35	26-6386-35	26-6387-35	26-6388-35
16	40					26-6385-40	26-6386-40	26-6387-40	26-6388-40



**Bumm**  
max. 29 cm/11½"

Fig.	mm	Mealleable	
		Sharp	Blunt
0	16.0	26-6389-16	26-6390-16
1	18.0	26-6389-18	26-6390-18
2	19.5	26-6389-19	26-6390-19
3	21.5	26-6389-21	26-6390-21
4	23.5	26-6389-23	26-6390-23
5	26.0	26-6389-26	26-6390-26
6	28.5	26-6389-28	26-6390-28



Blunt

Sharp

**Blake (Zweifel)**  
26-6391-27 27 cm/10½"  
26-6391-31 31 cm/12¼"



GYNECOLOGY

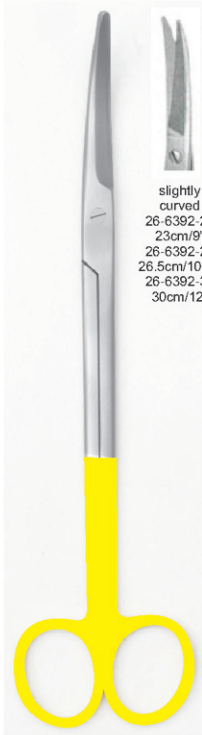

**Zeppelin Scissor with TC**

slightly curved  
26-6392-23  
23cm/9"  
26-6392-26  
26.5cm/10 1/2"  
26-6392-30  
30cm/12"

curved  
26-6393-23  
23cm/9"  
26-6393-26  
26.5cm/10 1/2"  
26-6393-30  
30cm/12"

Fully curved  
26-6394-23  
23cm/9"  
26-6394-26  
26.5cm/10 1/2"  
26-6394-30  
30cm/12"

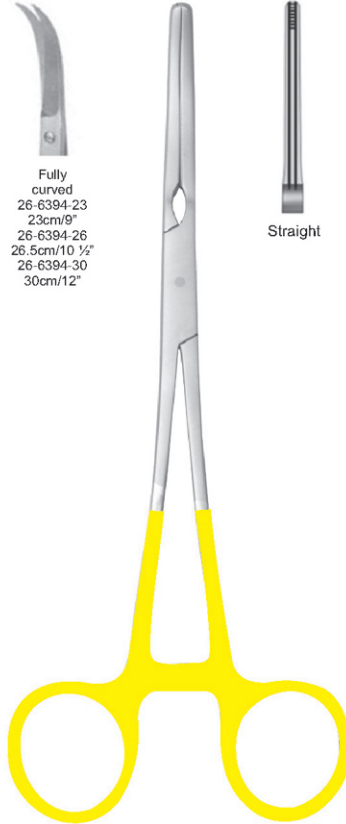

**Zeppelin Clamps**

offset handle with gold rings (without TC)

Straight	26-6395-21	26-6399-24	26-6403-30	26-6407-35
Slightly Curved	26-6396-21	26-6400-24	26-6404-30	26-6408-35
Strongly Curved	26-6397-21	26-6401-24	26-6405-30	26-6409-35
Angled	26-6398-21	26-6402-24	26-6406-30	26-6410-35
	21.5cm/8 1/2"	24cm/9 1/2"	30cm/12"	35cm/14"

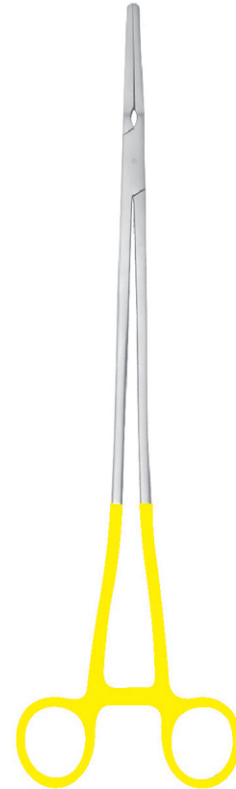

**Zeppelin Clamps**

Straight Handle with gold rings (without TC)

Straight	26-6411-21	26-6415-24	26-6419-30	26-6423-35
Slightly Curved	26-6412-21	26-6416-24	26-6420-30	26-6424-35
Strongly Curved	26-6413-21	26-6417-24	26-6421-30	26-6425-35
Angled	26-6414-21	26-6418-24	26-6422-30	26-6426-35
	21.5cm/8 1/2"	24cm/9 1/2"	30cm/12"	35cm/14"